

## WRINKLING OF SMOOTH MAPPINGS III FOLIATIONS OF CODIMENSION GREATER THAN ONE

Y. ELIASHBERG<sup>1</sup> — N. M. MISHACHEV<sup>2</sup>

---

*To Jürgen Moser on his 70-th birthday*

### 0. Introduction

This is the third paper in our Wrinkling saga (see [EM1], [EM2]). The first paper [EM1] was devoted to the foundations of the method. The second paper [EM2], as well as the current one are devoted to the applications of the wrinkling process. In [EM2] we proved, among other results, a generalized Igusa's theorem about functions with moderate singularities.

The current paper is devoted to applications of the wrinkling method in the foliation theory. The results of this paper essentially overlap with our paper [ME], which was written twenty years ago, soon after Thurston's remarkable discovery (see [Th1]) of an  $h$ -principle for foliations of codimension greater than one on closed manifolds. The paper [ME] contained an alternative proof of Thurston's theorem from [Th1], and was based on the technique of surgery of singularities which was developed in [E2]. The proof presented in this paper is based on the wrinkling method. Although essentially similar to our proof in [ME], the current proof is, in our opinion, more transparent and easier to understand. Besides Thurston's theorem we prove here a generalized version of our results from [ME] related to families of foliations.

---

1991 *Mathematics Subject Classification.* 57R30, 57R32.

*Key words and phrases.* Folds, cusps, wrinkles, foliation,  $h$ -principle.

<sup>1</sup>Partially supported by the NSF grant DMS-9626430.

<sup>2</sup>Partially supported by COBASE grant 15953 and NSF grant DMS-9626430.

## 1. Folds, cusps and wrinkles

**1.1. Folds and cusps.** Let  $M$  and  $Q$  be smooth manifolds of dimensions  $n$  and  $q$ , respectively, where  $n \geq q$ . For a smooth map  $f : M \rightarrow Q$  we will denote by  $\Sigma(f)$  the set of its singular points, i.e.

$$\Sigma(f) = \{p \in M, \text{rank } d_p f < q\}.$$

A point  $p \in \Sigma(f)$  is called a *fold* type singularity or a *fold* of index  $s$  if near the point  $p$  the map  $f$  is equivalent to the map  $\mathbb{R}^{q-1} \times \mathbb{R}^{n-q+1} \rightarrow \mathbb{R}^{q-1} \times \mathbb{R}^1$  given by the formula

$$(1) \quad (y, x) \mapsto \left( y, -\sum_1^s x_i^2 + \sum_{s+1}^{n-q+1} x_j^2 \right)$$

where  $x = (x_1, \dots, x_{n-q+1}) \in \mathbb{R}^{n-q+1}$  and  $y \in \mathbb{R}^{q-1}$ . For  $Q = \mathbb{R}^1$  this is just a nondegenerate index  $s$  critical point of the function  $f : M \rightarrow \mathbb{R}^1$ .

Let  $q > 1$ . A point  $p \in \Sigma(f)$  is called a *cusplike* type singularity or a *cusplike* of index  $s+1/2$  if near the point  $p$  the map  $f$  is equivalent to the map  $\mathbb{R}^{q-1} \times \mathbb{R}^1 \times \mathbb{R}^{n-q} \rightarrow \mathbb{R}^{q-1} \times \mathbb{R}^1$  given by the formula

$$(2) \quad (y, z, x) \mapsto \left( y, z^3 + 3y_1 z - \sum_1^s x_i^2 + \sum_{s+1}^{n-q} x_j^2 \right)$$

where  $x = (x_1, \dots, x_{n-q}) \in \mathbb{R}^{n-q}$ ,  $z \in \mathbb{R}^1$ ,  $y = (y_1, \dots, y_{q-1}) \in \mathbb{R}^{q-1}$ .

For  $q \geq 1$  a point  $p \in \Sigma(f)$  is called an *embryolike* type singularity or an *embryolike* of index  $s+1/2$  if  $f$  is equivalent near  $p$  to the map  $\mathbb{R}^{q-1} \times \mathbb{R}^1 \times \mathbb{R}^{n-q} \rightarrow \mathbb{R}^{q-1} \times \mathbb{R}^1$  given by the formula

$$(3) \quad (y, z, x) \mapsto \left( y, z^3 + 3|y|^2 z - \sum_1^s x_i^2 + \sum_{s+1}^{n-q} x_j^2 \right)$$

where  $x \in \mathbb{R}^{n-q}$ ,  $y \in \mathbb{R}^{q-1}$ ,  $z \in \mathbb{R}^1$ ,  $|y|^2 = \sum_1^{q-1} y_i^2$ . The set of all folds of  $f$  is denoted by  $\Sigma^{10}(f)$ , the set of cusps by  $\Sigma^{11}(f)$  and the closure  $\overline{\Sigma^{10}(f)}$  by  $\Sigma^1(f)$ .

Notice that folds and cusps are stable singularities for individual maps, while embryos are stable singularities only for 1-parametric families of mappings. For a generic perturbation of an individual map embryos either disappear or give birth to wrinkles which we consider in the next section.

**REMARK.** When  $q > 1$  there is no invariant way to distinguish between indices  $\alpha$  and  $n-q+1-\alpha$  for folds, cusps, or embryos, because this distinction requires a choice of an orientation of  $T_{f(p)}/df(T_p(M))$  for a singular point  $p \in \Sigma(f)$ . Thus one can invariantly define only the *reduced* index  $\min(\alpha, n-q+1-\alpha)$  which takes values  $0, \dots, [n-q+1/2]$  for folds and  $1/2, \dots, [n-q/2] + 1/2$  for cusps and embryos. However, for purposes of this paper this is not essential, because for all maps which we consider, the 1-dimensional bundle  $TQ|_{f(\Sigma(f))}/df(TM)$

will be orientable, and thus we can allow indices to take values  $0, \dots, n - q + 1$  for folds, and  $1/2, \dots, n - q + 1/2$  for cusps, by choosing an orientation of this bundle.

**1.2. Wrinkles and wrinkled maps.** Consider the map  $w(n, q, s) : \mathbb{R}^{q-1} \times \mathbb{R}^1 \times \mathbb{R}^{n-q} \rightarrow \mathbb{R}^{q-1} \times \mathbb{R}^1$  given by the formula

$$(4) \quad (y, z, x) \mapsto \left( y, z^3 + 3(|y|^2 - 1)z - \sum_1^s x_i^2 + \sum_{s+1}^{n-q} x_j^2 \right),$$

where  $y \in \mathbb{R}^{q-1}$ ,  $z \in \mathbb{R}^1$ ,  $x \in \mathbb{R}^{n-q}$  and  $|y|^2 = \sum_1^{q-1} y_i^2$ .

The singularity  $\Sigma^1(w(n, q, s))$  is the  $(q - 1)$ -dimensional sphere

$$S^{q-1} = S^{q-1} \times 0 \subset \mathbb{R}^q \times \mathbb{R}^{n-q},$$

whose equator  $\{x = 0, z = 0, |y| = 1\} \subset \Sigma^1(w(n, q, s))$  consists of cusp points of index  $s + 1/2$ . The upper hemisphere  $\Sigma^1(w) \cap \{z > 0\}$  consists of folds of index  $s$ , while the lower one  $\Sigma^1(w) \cap \{z < 0\}$  consists of folds of index  $s + 1$ .

A map  $f : U \rightarrow Q$  defined on an open subset  $U \subset M$  is called a *wrinkle* of index  $s + 1/2$  if it is equivalent to the restriction of  $w(n, q, s)$  to an open neighbourhood  $W^n$  of the disk  $D^q = D^q \times 0 \subset \mathbb{R}^q \times \mathbb{R}^{n-q}$ . Sometimes we will use the term “wrinkle” also for the singularity  $\Sigma(f)$  of a wrinkle  $f$ .

REMARK. The neighbourhood  $W^n$  in the definition of a wrinkle is not fixed, though one could choose a (small enough) “canonical”  $W_0^n$ , such that for any neighbourhood  $W^n \supset D^q$  there would exist  $W_1^n \subset W^n$  with  $w(n, q, s)|_{W_1^n}$  equivalent to  $w(n, q, s)|_{W_0^n}$ . However, we do not need such a degree of canonization.

Notice that for  $q = 1$  the wrinkle is a function with two nondegenerate critical points of indices  $s$  and  $s + 1$  given in a neighbourhood of a gradient trajectory which connects the two critical points.

Restrictions of the map  $w(n, q, s)$  to the subspaces  $y_1 = t$ , viewed as maps  $\mathbb{R}^{n-1} \rightarrow \mathbb{R}^{q-1}$ , are non-singular maps for  $|t| > 1$ , equivalent to  $w(n - 1, q - 1, s)$  for  $|t| < 1$ , and to embryos for  $t = \pm 1$ .

Although the differential  $dw(n, q, s) : T(\mathbb{R}^n) \rightarrow T(\mathbb{R}^q)$  degenerates at points of  $\Sigma(w)$ , it can be canonically *regularized*. Namely, we can substitute the element  $3(z^2 + |y|^2 - 1)$  in the Jacobi matrix of  $w(n, q, s)$  by a function  $\gamma$  which coincides with  $3(z^2 + |y|^2 - 1)$  outside an arbitrary small neighbourhood  $V$  of the disc  $D$  and does not vanish along  $V \cap \{x = 0\}$ . The new bundle map  $\mathcal{R}(dw) : T(\mathbb{R}^n) \rightarrow T(\mathbb{R}^q)$  provides a homotopically canonical extension of the map  $dw : T(\mathbb{R}^n \setminus W^n) \rightarrow T(\mathbb{R}^q)$  to an epimorphism (fiberwise surjective bundle map)  $T(\mathbb{R}^n) \rightarrow T(\mathbb{R}^q)$ . We call  $\mathcal{R}(dw)$  the *regularized differential* of the map  $w(n, q, s)$ .

A map  $f : M \rightarrow Q$  is called *wrinkled* if there exist disjoint open subsets  $U_1, \dots, U_l \subset M$ , such that  $f|_{M \setminus U}$ ,  $U = \bigcup_1^l U_i$ , is a submersion (i.e. has rank

equal  $q$ ) and for each  $i = 1, \dots, l$  the restriction  $f|_{U_i}$  is a wrinkle. Notice that the sets  $U_i, i = 1, \dots, l$ , are included into the structure of a wrinkled map.

The singular locus  $\Sigma(f)$  of a wrinkled map  $f$  is a union of  $(q - 1)$ -dimensional wrinkles  $S_i = \Sigma^1(f|_{U_i}) \subset U_i$ . Each  $S_i$  has a  $(q - 2)$ -dimensional equator  $T_i \subset S_i$  of cusps which divides  $S_i$  into 2 hemispheres of folds of 2 neighbouring indices. The differential  $df : T(M) \rightarrow T(Q)$  can be regularized to obtain an epimorphism  $\mathcal{R}(df) : T(M) \rightarrow T(Q)$ . To get  $\mathcal{R}(df)$  we regularize  $df|_{U_i}$  for each wrinkle  $f|_{U_i}$ .

**1.3. Fibered wrinkles.** All the notions from Section 1.2 can be extended to the parametric case.

A *fibered (over  $B$ ) map* is a commutative diagram

$$\begin{array}{ccc} U & \xrightarrow{f} & V \\ p \searrow & & \swarrow q \\ & B & \end{array}$$

where  $p$  and  $q$  are submersions. We will often write the fibered map as just  $f : U \rightarrow V$  if  $B, p$  and  $q$  are implied from the context.

Given a fibered map

$$\begin{array}{ccc} X & \xrightarrow{f} & Y \\ p \searrow & & \swarrow q \\ & B & \end{array}$$

we denote by  $T_B X$  and  $T_B Y$  the subbundles  $\text{Ker } p \subset TX$  and  $\text{Ker } q \subset TY$ . They are tangent to the foliations of  $X$  and  $Y$  formed by preimages  $p^{-1}(b) \subset X, q^{-1}(b) \subset Y, b \in B$ .

The fibered homotopies, fibered differentials, fibered submersions and so on are naturally defined in the category of fibered maps (see [EM1]). For example, the *fibered differential* of  $f : X \rightarrow Y$  is the restriction  $d_B f = df|_{T_B X} : T_B X \rightarrow T_B Y$ . Notice that  $d_B f$  itself has the structure of a map fibered over  $B$ :

$$\begin{array}{ccc} T_B X & \xrightarrow{d_B f} & T_B Y \\ \bar{p} \searrow & & \swarrow \bar{q} \\ & B & \end{array}$$

Here  $\bar{p}$  and  $\bar{q}$  are compositions of  $p$  and  $q$  with the projections  $T_B X \rightarrow X$  and  $T_B Y \rightarrow Y$ .

Two fibered maps

$$\begin{array}{ccc} U & \xrightarrow{f} & V \\ p \searrow & & \swarrow q \\ & B & \end{array} \quad \text{and} \quad \begin{array}{ccc} U' & \xrightarrow{f'} & V' \\ p' \searrow & & \swarrow q' \\ & B' & \end{array}$$

are called *equivalent* if there exist open subsets  $A \subset B, A' \subset B', W \subset V, W' \subset V'$  with  $f(U) \subset W, p(U) \subset A, p'(U') \subset A', f'(U) \subset W', f(U') \subset A'$  and

diffeomorphisms

$$\phi : U \rightarrow U', \quad \psi : W \rightarrow W', \quad s : A \rightarrow A'$$

such that they form the following commutative diagram

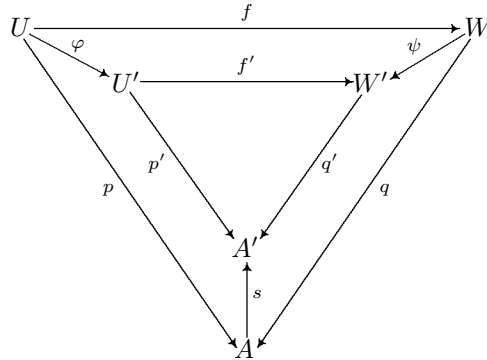

For any integer  $k$ ,  $0 \leq k \leq q - 1$ , the map  $w(n, q, s)$  can be considered as a fibered map over  $\mathbb{R}^k$ . Namely, we have a commutative diagram

$$\begin{array}{ccc} \mathbb{R}^k \times \mathbb{R}^{q-1-k} \times \mathbb{R}^1 \times \mathbb{R}^{n-q} & \xrightarrow{w(n,q,s)} & \mathbb{R}^k \times \mathbb{R}^{q-1-k} \times \mathbb{R}^1 \\ \text{pr} \searrow & & \swarrow \text{pr} \\ & \mathbb{R}^k & \end{array}$$

where  $\text{pr}$  is the projection to the first factor. We shall refer to this fibered map as  $w_k(n, q, s)$ . A fibered map equivalent to the restriction of  $w_k(n, q, s)$  to an open neighbourhood  $W^n \supset D$  is called a *fibered wrinkle*<sup>1</sup>

The regularized differential  $\mathcal{R}(dw_k(n, q, s))$  is a fibered (over  $\mathbb{R}^k$ ) epimorphism

$$\mathbb{R}^k \times T(\mathbb{R}^{q-1-k} \times \mathbb{R}^1 \times \mathbb{R}^{n-q}) \xrightarrow{\mathcal{R}(dw_k(n,q,s))} \mathbb{R}^k \times T(\mathbb{R}^{q-1-k} \times \mathbb{R}^1)$$

A fibered map  $f : M \rightarrow Q$  is called a *fibered wrinkled map* if there exist disjoint open sets  $U_1, U_2, \dots, U_l \subset M$ , such that  $f|_{M \setminus U}, U = \bigcup_1^l U_i$ , is a fibered submersion, and for each  $i = 1, \dots, l$  the restriction  $f|_{U_i}$  is a fibered wrinkle. The restrictions of a fibered wrinkled map to fibers may have, in addition to wrinkles, embryo singularities.

Similarly to the non-parametric case one can define the regularized differential of a fibered over  $B$  wrinkled map  $f : M \rightarrow Q$ , which is a fibered epimorphism  $\mathcal{R}(d_B f) : T_B M \rightarrow T_B Q$ .

**1.4. Main theorems.** The following Theorem 1.4.1 and its parametric version 1.4.2 are the main results of our paper [EM1]:

---

<sup>1</sup>There was a misprint in the definition of fibered wrinkles in [EM1]: the important words “the restriction of ... to an open neighbourhood  $W^n \supset D$ ” were omitted.

**THEOREM 1.4.1 (Wrinkled mappings).** *Let  $F : T(M) \rightarrow T(Q)$  be an epimorphism which covers a map  $f : M \rightarrow Q$ . Suppose that  $f$  is a submersion on a neighbourhood of a closed subset  $K \subset M$ , and  $F$  coincides with  $df$  over that neighbourhood. Then there exists a wrinkled map  $g : M \rightarrow Q$  which coincides with  $f$  near  $K$ , and such that  $\mathcal{R}(dg)$  and  $F$  are homotopic rel.  $T(M)|_K$ . Moreover, the map  $g$  can be chosen arbitrary  $C^0$ -close to  $f$ , and his wrinkles can be made arbitrary small.*

**THEOREM 1.4.2 (Fibered wrinkled mappings).** *Let  $f : M \rightarrow Q$  be a fibered over  $B$  map covered by a fibered epimorphism  $F : T_B(M) \rightarrow T_B(Q)$ . Suppose that  $F$  coincides with  $df$  near a closed subset  $K \subset M$  (in particular,  $f$  is a fibered submersion near  $K$ ), then there exists a fibered wrinkled map  $g : M \rightarrow Q$  which extends  $f$  from a neighbourhood of  $K$ , and such that the fibered epimorphisms  $\mathcal{R}(dg)$  and  $F$  are homotopic rel.  $T_B(M)|_K$ . Moreover, the map  $g$  can be chosen arbitrary  $C^0$ -close to  $f$ , and his wrinkles can be made arbitrary small.*

**1.5. Round wrinkles.** For purposes of Section 2 it will be convenient to have a slightly modified version of Theorems 1.4.1 and 1.4.2, when the usual wrinkles are substituted by the *round* ones.

Let  $q \geq 2$ . The *standard round wrinkle* is the map

$$w_\circ(n, q, s) : S^1 \times \mathbb{R}^{q-2} \times \mathbb{R}^1 \times \mathbb{R}^{n-q} \rightarrow S^1 \times \mathbb{R}^{q-2} \times \mathbb{R}^1,$$

given by the formula

$$w_\circ(n, q, s) = \text{Id}_{S^1} \times w(n - 1, q - 1, s).$$

The singularity  $\Sigma^1(w_\circ(n, q, s))$  is the product  $S^1 \times \Sigma^1(w(n - 1, q - 1, s)) = S^1 \times S^{q-2}$ .

Notice, that the restrictions of the standard round wrinkle  $w_\circ(n, q, s)$  to the subspaces  $y_1 = t$  viewed as maps  $S^1 \times \mathbb{R}^{n-2} \rightarrow S^1 \times \mathbb{R}^{q-2}$  are non-singular maps for  $|t| > 1$ , equivalent to the standard round wrinkles  $w_\circ(n - 1, q - 1, s)$  for  $|t| < 1$ , and equivalent to the *round embryo*  $\text{Id}_{S^1} \times [w(n - 1, q - 1, s)]_{y_1=\pm 1}$  for  $t = \pm 1$ .

The *regularized differential*

$$\mathcal{R}(dw_\circ) : T(S^1 \times \mathbb{R}^{n-1}) \rightarrow T(S^1 \times \mathbb{R}^{q-1})$$

of the map  $w_\circ(n, q, s)$  is defined as

$$\mathcal{R}(dw_\circ(n, q, s)) = d(\text{Id}_{S^1}) \times \mathcal{R}(dw(n - 1, q - 1, s)).$$

For an open subset  $U \subset M$  a map  $f : U \rightarrow Q$  is called a *round wrinkle* of index  $s + 1/2$  if it can be presented as a composition

$$U \xrightarrow{g} S^1 \times \mathbb{R}^{q-2} \times \mathbb{R}^{n-q+1} \xrightarrow{w_\circ(n, q, s)} S^1 \times \mathbb{R}^{q-2} \times \mathbb{R}^1 \xrightarrow{h} Q$$

where  $g$  is a diffeomorphism and  $h$  is an immersion.

We will use the term “round wrinkle” also for the singularity  $\Sigma(f)$  of the round wrinkle  $f$ .

A map  $f : M \rightarrow Q$  is called *round wrinkled* if there exist disjoint open balls  $\tilde{U}_1, \dots, \tilde{U}_l \subset M$  and (unknotted)  $n$ -dimensional “donuts”  $U_1 \subset \tilde{U}_1, \dots, U_l \subset \tilde{U}_l$ , diffeomorphic to  $S^1 \times \text{Int } D^{n-1}$ , such that  $f|_{M \setminus U}, U = \bigcup_1^l U_i$ , is a submersion, and for each  $i = 1, \dots, l$  the restriction  $f|_{U_i}$  is a round wrinkle.

The differential  $df : T(M) \rightarrow T(Q)$  of a round wrinkled map  $f$  can be regularized to obtain a surjective homomorphism  $\mathcal{R}(df) : T(M) \rightarrow T(Q)$ . To get the desired regularization  $\mathcal{R}(df)$  we regularize  $df|_{U_i}$  for each round wrinkle  $f|_{U_i}$ .

We leave to the reader to develop a *fibred* version of the “round wrinkle theory”. As in Section 1.3 the restrictions of a fibred round wrinkled map to fibers may have, in addition to round wrinkles, round embryos singularities.

For  $q \geq 2$  the following Proposition 1.5.1 allows us to substitute in Theorems 1.4.1 and 1.4.2 the usual wrinkles by the round ones.

**PROPOSITION 1.5.1 (Rounding a wrinkle).** *Suppose that  $q \geq 2$ . Then there exists a round wrinkled map  $\hat{w}_\circ : \mathbb{R}^{q-1} \times \mathbb{R} \times \mathbb{R}^{n-q} \rightarrow \mathbb{R}^{q-1} \times \mathbb{R}$  which coincides with the standard wrinkle  $w(n, q, s)$  outside of an arbitrary small neighbourhood  $W$  of the disk  $D = D^q \times 0 \subset \mathbb{R}^q \times \mathbb{R}^{n-q}$ , and such that the regularized differentials  $\mathcal{R}(dw(n, q, s))$  and  $\mathcal{R}(d\hat{w}_\circ)$  are homotopic as epimorphisms fixed near the boundary of  $U$ .*

**PROOF.** Take an embedding  $\gamma$  of the circle  $S = \mathbb{R}/4\mathbb{Z} = [-2, 2]/\{-2, 2\}$  into  $W \cap (\mathbb{R}^q \times 0)$ , such that  $\gamma(t) = (t, 0, \dots, 0)$  for  $t \in (-1 - \varepsilon, 1 + \varepsilon)$  for a small  $\varepsilon > 0$ , see Figure 1.

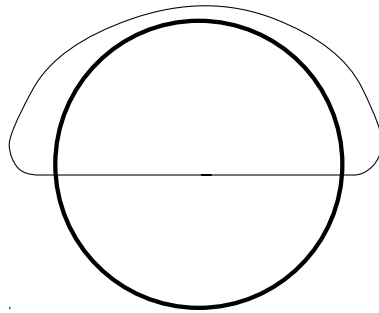

FIGURE 1. Embedding  $\gamma$

Let  $\theta = \theta_\varepsilon$  be a positive  $C^\infty$ -function  $S \rightarrow \mathbb{R}$  such that  $\sqrt{1-t^2} < \theta(t) < \sqrt{1-t^2} + \varepsilon$  for  $t \in [-1, 1]$  and  $\theta(t) \leq \varepsilon$  for  $t \notin [-1, 1]$ . Consider a neighbourhood  $U_\theta$  of  $S \times 0$  in  $S \times \mathbb{R}^{q-2} \times \mathbb{R} \times \mathbb{R}^{n-q}$ :

$$U_\theta = \{(t, v, x) \mid \|v\| < \theta(t), |x| < \varepsilon, t \in S, v \in \mathbb{R}^{q-2} \times \mathbb{R} \times \mathbb{R}^{n-q}\}.$$

Notice that the map  $w(n, q, s)$  is non-singular along the curve  $C = \gamma((1, 2)) \cup \gamma((-2, -1))$  and, moreover, the restriction  $w(n, q, s)|_C$  is an immersion. It follows that for a sufficiently small  $\varepsilon > 0$  there exist a neighbourhood  $U$  of  $D \cup C$  in  $W$ , and a diffeomorphism  $h : U_\theta \rightarrow U$ , such that the map  $w(n, q, s) \circ h$  can be presented as a composition

$$U_\theta \xrightarrow{\tilde{w}} S \times \mathbb{R}^{q-2} \times \mathbb{R} \xrightarrow{g} \mathbb{R}^{q-1} \times \mathbb{R},$$

where  $g$  is an immersion, and  $\tilde{w}$  has the form

$$(t, y', z, x) \mapsto \left( t, y', z^3 + 3(\alpha(t) + |y'|^2 - 1)z - \sum_1^s x_i^2 + \sum_{s+1}^{n-q} x_j^2 \right),$$

where  $t \in S$ ,  $y' \in \mathbb{R}^{q-2}$ ,  $z \in \mathbb{R}$ ,  $x \in \mathbb{R}^{n-q}$ ,  $\alpha(t) = t^2$  for  $t \in [-1, 1]$ , and  $\alpha(t) > 1$  otherwise. The map  $\tilde{w}$  has a (fibered) wrinkle over  $[-1, 1] \subset S$ . For a small  $\delta > 0$  let us take a function  $\beta : S \rightarrow \mathbb{R}$  such that  $\beta(t) = t^2$  on  $[-1 + \delta, 1 - \delta]$  and  $(1 - \delta)^2 \leq \beta(t) < 1$  for  $t \notin [-1 + \delta, 1 - \delta]$ . Choose also a  $C^\infty$ -cut-off function  $\sigma : \mathbb{R}_+ \rightarrow [0, 1]$  such that  $\sigma(t) = 1$  for  $t \leq \varepsilon/3$ ,  $\sigma(t) = 0$  for  $t > 2\varepsilon/3$ , and  $|\sigma'(t)| < 4/\varepsilon$  for all  $t \in \mathbb{R}_+$ . Set

$$\begin{aligned} & \hat{w}(t, y', z, x) \\ &= \left( t, y', z^3 + 3(\sigma(|x|)\beta(t) + (1 - \sigma(|x|))\alpha(t) + |y'|^2 - 1)z - \sum_1^s x_i^2 + \sum_{s+1}^{n-q} x_j^2 \right). \end{aligned}$$

The map  $\hat{w}$  is fibered over  $S$ , and coincides with  $\tilde{w}$  outside a  $2\varepsilon/3$ -neighbourhood of  $S \times 0 \subset U_\theta$ . For a sufficiently small  $\delta > 0$  the restrictions of  $\hat{w}$  to the fibers  $\{t = \text{const}\}$  are wrinkles. Therefore the map  $\hat{w}$  is fiberwise equivalent to the standard round wrinkle  $w_\circ(n, q, s)$ , and hence the map  $g \circ \hat{w} \circ h : U \rightarrow \mathbb{R}^{q-1} \times \mathbb{R}$  is a round wrinkle as well. The map  $\hat{w}$  coincides with  $w(n, q, s)$  near the boundary  $\partial U$  and thus defines the desired modification of  $w(n, q, s)$  into a round wrinkled map, denoted by  $\hat{w}_\circ$ . It remains to check that the regularized differentials  $\mathcal{R}(dw(n, q, s))$  and  $\mathcal{R}(d\hat{w}_\circ)$  are homotopic as epimorphisms fixed near the boundary of  $U$ , but this is straightforward.  $\square$

REMARK. Except for the case  $n = q = 2$ , the map  $\hat{w}_\circ$  can be chosen in such a way that its restriction to the singularity  $\Sigma(\hat{w}_\circ)$  is an embedding (rather than an immersion), though the definition of a round wrinkle does not require it.

A fibered analog of Lemma 1.5.1 also holds true, see Figure 3.

## 2. Foliations of codimension $> 1$ on closed manifolds

**2.1. Foliations and augmented Haefliger structures.** We review and refine in this section some notions from the theory of foliations (see [L] and [F] for more details). In what follows we do not distinguish in notations between a bundle and its total space when the distinction is clear from the context.



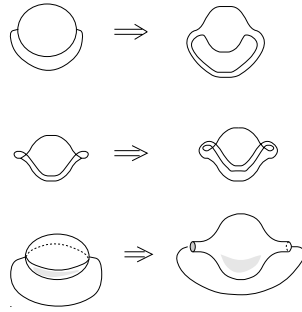

FIGURE 2. Rounding a wrinkle, the cases  $n = q = 2$  and  $n = q = 3$

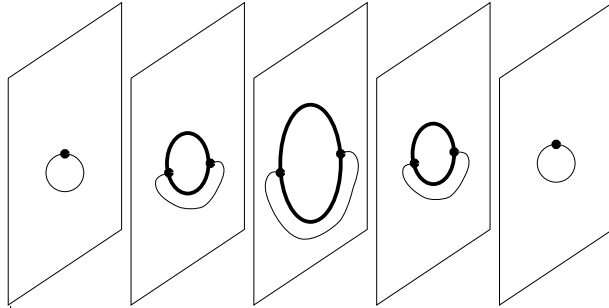

FIGURE 3. Rounding a fibered wrinkle, the case  $n = q = 3, k = 1$

An integrable  $(n - q)$ -dimensional tangent plane field  $\xi$  on a  $n$ -dimension manifold  $M$  defines a decomposition  $\mathcal{F}$  of  $M$  by its integral leaves, which is called a *foliation of codimension  $q$* . For each point  $x \in M$  there exists a neighbourhood  $U \subset M$  and a submersion  $s : U \rightarrow \mathbb{R}^q$  such that the foliation  $\mathcal{F}|_U$  coincides with the foliation  $\bigcup_{y \in s(U)} s^{-1}(y)$  by the pre-images of points under the submersion  $s$ . Thus, alternatively a foliation of codimension  $q$  can be defined through an atlas of local submersions into  $\mathbb{R}^q$  related on their common parts by partially defined diffeomorphisms of  $\mathbb{R}^q$ . The class of smoothness of these gluing diffeomorphisms is very important in the theory of foliations. However, in this paper we assume all foliations to be  $C^\infty$ -smooth, which is equivalent to the  $C^\infty$ -smoothness of the tangent plane field  $\xi$  which integrates to this foliation. We will also require all foliations to be transversal to  $\partial M$  if the manifold  $M$  has a non-empty boundary.

The notations  $\tau(\mathcal{F})$  and  $\nu(\mathcal{F})$  stands for the tangent and the normal bundles to the foliation  $\mathcal{F}$ . Sometimes we will be using the term “foliation” for an integrable plane field  $\xi$  itself, thus not distinguishing between a foliation and its tangent bundle. We identify  $\nu(\mathcal{F})$  with the orthogonal complement to  $\tau(\mathcal{F}) \subset TM$ , assuming that  $M$  is endowed with a Riemannian metric. We will also assume that in the chosen metric the foliation  $\mathcal{F}$  is orthogonal to the boundary  $\partial M$ , i.e.  $\nu(\mathcal{F})|_{\partial M} \subset T(\partial M)$ .

Foliations behaves contravariantly under mappings *transversal to a foliation on the target manifold*. We will denote by  $f^*\mathcal{F}$  the foliation on  $M$  induced by a map  $f : M \rightarrow Q$  transversal to a foliation  $\mathcal{F}$  on  $Q$ .

Let us consider the following four equivalence relations for foliations. Two foliations  $\mathcal{F}_0$  and  $\mathcal{F}_1$  of the same codimension  $q$  on a manifold  $M$  are said to be

- *homotopic*, if they are homotopic as integrable plane fields;
- *concordant*, if there exists a foliation  $\mathcal{F}$  of codimension  $q$  (a *concordance*) on  $M \times I$  such that  $\mathcal{F}|_{M \times 0} = \mathcal{F}_0$  and  $\mathcal{F}|_{M \times 1} = \mathcal{F}_1$ ;
- *strongly concordant*, if there exists a concordance  $\mathcal{F}$  such that the inclusion  $i : \nu(\mathcal{F}) \hookrightarrow T(M \times I)$  is homotopic through a family of fixed over  $M \times 0 \cup M \times 1$  bundle monomorphisms  $i_t : \nu(\mathcal{F}) \rightarrow T(M \times I)$  to a *horizontal* monomorphism  $\nu(\mathcal{F}) \rightarrow TM \times I \hookrightarrow T(M \times I)$ ; here  $TM \times I$  denotes the subbundle of  $T(M \times I)$  tangent to the slices  $M \times t$ ,  $t \in I$ ;
- *integrable homotopic*, if there exists a concordance  $\mathcal{F}$  transversal to  $M \times t$  for every  $t \in I$ .

Of course, integrable homotopy is the strongest of four equivalences. Moreover, if the manifold  $M$  is closed then integrably homotopic foliations are isotopic (see [M]). In remarkable article [Th3] Thurston constructed a continuous family of foliations on  $S^3$ , which are pairwise nonconcordant. Therefore, *homotopy do not imply concordance*. On the contrary, *strong concordance* implies homotopy of foliations of codimension  $> 2$ , see [ME] and Theorem 2.2.2 below.

A *Haefliger structure of codimension  $q$*  (or  $\Gamma_q$ -*structure*) on a manifold  $M$  is a pair  $H = (\nu, \mathcal{H})$ , where  $\nu$  is a  $q$ -dimensional vector bundle, called the normal bundle of  $H$ , and  $\mathcal{H}$  is a (germ of) a foliation of codimension  $q$  on (the total space of)  $\nu$  near the zero-section  $M \subset \nu$ , which is transversal to the fibers of  $\nu$  (see Figure 4). Notice that the foliation  $\mathcal{H}$  need not to be transversal to  $M$ .

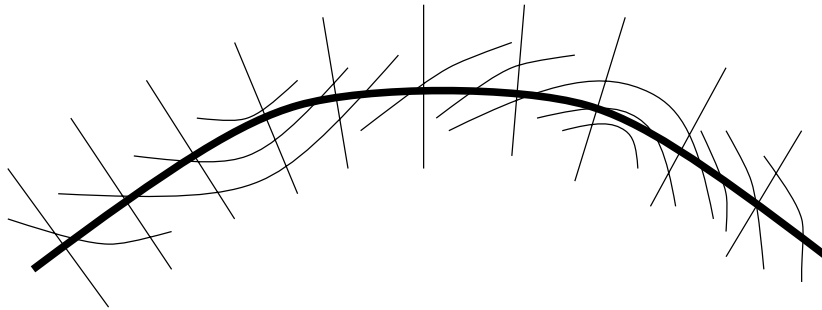

FIGURE 4. Haefliger structure

A Haefliger structure  $H = (\nu, \mathcal{H})$  on a manifold  $M$  is called *regular*, if  $\mathcal{H}$  is transversal to  $M$ . For a regular Haefliger structure  $H = (\nu, \mathcal{H})$  the intersection

$\mathcal{F} = \mathcal{H} \cap M$  is a foliation. Conversely, for any foliation  $\mathcal{F}$  on  $M$  we can canonically construct a regular Haefliger structure  $H_{\mathcal{F}} = (\nu(\mathcal{F}), \mathcal{H}_{\mathcal{F}} = (\exp \circ i)^* \mathcal{F})$  where  $i : \nu(\mathcal{F}) \hookrightarrow TM$  is the inclusion and  $\exp : TM \rightarrow M$  is the exponential map (see Figure 5). The foliation  $\mathcal{H}_{\mathcal{F}}$  is transversal to  $M$  and  $\mathcal{H}_{\mathcal{F}} \cap M = \mathcal{F}$ . We will identify the foliation  $\mathcal{F}$  with the regular Haefliger structure  $H_{\mathcal{F}}$ .

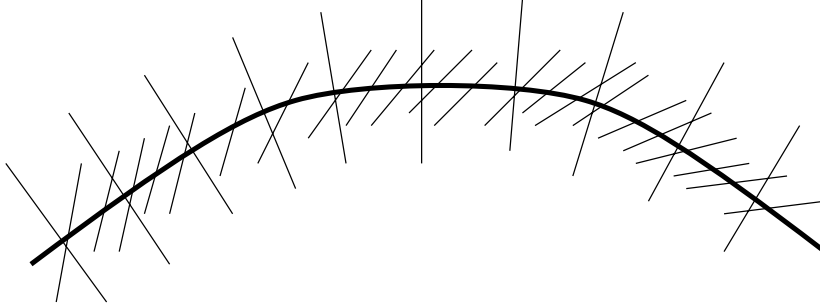

FIGURE 5. Regular Haefliger structure

Similarly, a general Haefliger structure  $H$  can be viewed as a singular foliation. Its *singular locus*  $\Sigma(H)$  is a subset of the points of  $M$  where  $\mathcal{H}$  is not transversal to  $M$ .

Another extreme class of Haefliger structures constitute flat structures. A Haefliger structure  $(\nu, \mathcal{H})$  is called *flat* if the zero-section is one of the leaves of  $\mathcal{H}$ , see Figure 6. In this case  $\Sigma(H) = M$ . Notice that the bundle  $\nu$  admits a flat Haefliger structure if and only if its structural group  $GL(q)$  can be reduced to a discrete group in a larger group of germs at the origin of diffeomorphisms  $(\mathbb{R}^q, \mathbf{0}) \rightarrow (\mathbb{R}^q, \mathbf{0})$ .

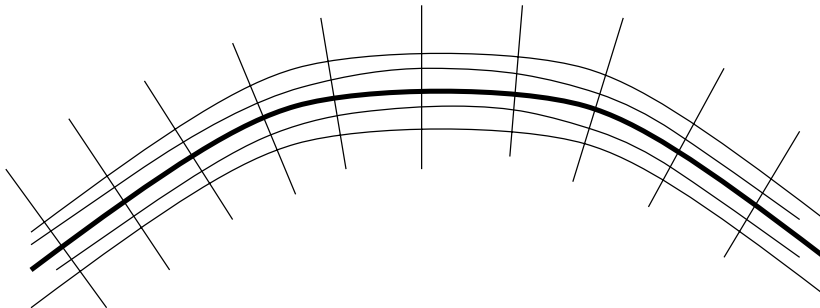

FIGURE 6. Flat Haefliger structure

An *augmented* Haefliger structure  $\mathbf{H}$  of codimension  $q$  on a manifold  $M$  is given by a triple  $(\nu, \mathcal{H}, i)$  where  $(\nu, \mathcal{H})$  is an (underlying) Haefliger structure

and  $i : \nu \rightarrow TM$  is a bundle monomorphism (the *augmentation*) such that  $i(\nu|_{\partial M}) \subset T(\partial M)$ .

An augmented Haefliger structure  $\mathbf{H} = (\nu, \mathcal{H}, i)$  on a manifold  $M$  is called *regular*, if the underlying  $H = (\nu, \mathcal{H})$  is regular, i.e  $H = H_{\mathcal{F}} = (\nu(\mathcal{F}), \mathcal{H}_{\mathcal{F}})$ , and  $i : \nu \rightarrow \nu(\mathcal{F}) \hookrightarrow TM$  is an inclusion generated by the projection along  $\mathcal{H}$ . Given a foliation  $\mathcal{F}$  on  $M$  we can canonically equip  $H_{\mathcal{F}}$  with the augmentation  $i : \nu(\mathcal{F}) \hookrightarrow TM$ , and, therefore, identify the foliation  $\mathcal{F}$  with the regular augmented Haefliger structure  $\mathbf{H}_{\mathcal{F}}$ .

Let  $\mathbf{H}_0$  and  $\mathbf{H}_1$  be two augmented Haefliger structure of codimension  $q$  on an  $n$ -manifold  $M$ . Let us define three equivalence relations for augmented Haefliger structures, which are parallel to the first three equivalences for foliations.

The structures  $\mathbf{H}_0$  and  $\mathbf{H}_1$  are said to be

- *homotopic*, if they are homotopic through augmented Haefliger structures;
- *concordant*, if there exists a codimension  $q$  augmented Haefliger structure  $\mathbf{H}$  (a *concordance*) on  $M \times I$  such that  $\mathbf{H}|_{M \times 0} = \mathbf{H}_0$  and  $\mathbf{H}|_{M \times 1} = \mathbf{H}_1$ ;
- *strongly concordant*, if there exists a concordance  $\mathbf{H}$  such that augmentation  $i : \nu \rightarrow T(M \times I)$  is homotopic to the composition  $\nu \rightarrow TM \times I \hookrightarrow T(M \times I)$  through bundle monomorphisms  $i_t : \nu \rightarrow T(M \times I)$  fixed over  $M \times 0 \cup M \times 1$ .

As it follows from definitions, strongly concordant augmented Haefliger structures are homotopic. The relations of homotopy and concordance can be similarly defined for (non-augmented) Haefliger structures.

Unlike foliations, Haefliger structures behaves contravariantly under *all mappings* of the underlying manifold, without any transversality conditions. Indeed, given a Haefliger structure  $(\nu, \mathcal{H})$  on a manifold  $N$  and a map  $\varphi : M \rightarrow N$  we induce a Haefliger structure  $\tilde{H} = (\tilde{\nu}, \tilde{\mathcal{H}}) = \varphi^*H$  on  $M$  by taking the induced bundle  $\tilde{\nu} = \varphi^*\nu$  and the (germ of) the foliation  $\tilde{\mathcal{H}} = \tilde{\varphi}^*(\mathcal{H})$ , where the bundle isomorphism  $\tilde{\varphi} : \tilde{\nu} \rightarrow \nu$  covers  $\varphi$ . Observe that  $\tilde{\varphi}$  is transversal to  $\mathcal{H}$ ; moreover, the restrictions of  $\tilde{\varphi}$  to fibers of the bundle  $\tilde{\nu}$  are transversal to  $\mathcal{H}$ , and hence  $\tilde{\mathcal{H}}$  is a germ of a non-singular foliation transversal to the fibers of the bundle  $\tilde{\nu}$ . A homotopy  $\varphi_t : M \rightarrow N$ ,  $t \in [0, 1]$ , induces a concordance between  $\varphi_0^*H$  and  $\varphi_1^*H$ . According to the standard homotopy techniques (see [B]) there exist a universal space  $B\Gamma$  and a universal Haefliger structure  $H_{\mathcal{U}}$  on it such that for any manifold  $M$  all Haefliger structures on  $M$  can be induced from the structure  $H_{\mathcal{U}}$  on  $B\Gamma$ , and concordance classes of these structures are in 1–1 correspondence with the homotopy classes of maps  $M \rightarrow B\Gamma$ .

If in addition to a map  $\varphi : M \rightarrow N$  we are given a *bundle epimorphism*  $\Phi : TM \rightarrow \nu$  which covers  $\varphi$ , then we can induce an *augmented* Haefliger structure

$\tilde{\mathbf{H}} = \Phi^*\mathbf{H} = (\tilde{\nu}, \tilde{\mathcal{H}}, \tilde{i})$  on  $M$  from an augmented structure  $\mathbf{H} = (\nu, \mathcal{H}, i)$  on  $N$ . Here we have  $(\tilde{\nu}, \tilde{\mathcal{H}}) = \varphi^*H$ , and the augmentation  $\tilde{i}$  is the composition of the canonical isomorphism  $\tilde{\nu} \rightarrow (\text{Ker } \Phi)^\perp$ , and the inclusion  $(\text{Ker } \Phi)^\perp \rightarrow TM$ , where we denote by  $(\text{Ker } \Phi)^\perp$  the orthogonal complement of  $\text{Ker } \Phi$  in  $TM$ . A homotopy  $\Phi_t : TM \rightarrow \nu$ ,  $t \in [0, 1]$ , of epimorphisms induces a strong concordance between  $\Phi_0^*\mathbf{H}$  and  $\Phi_1^*\mathbf{H}$ .

The following simple construction is very useful for what follows. Given a foliations  $\mathcal{F}$  on a manifold  $M$ , and  $\mathcal{G}$  on  $N$ , we denote by  $\mathcal{F} \times \mathcal{G}$  the *product foliation* whose leaves are products of the leaves of foliations  $\mathcal{F}$  and  $\mathcal{G}$ . It is in particular useful to consider products of  $\mathcal{F}$  with two trivial foliations on  $N$ , the 0-dimensional foliation  $\mathcal{O}_N$  by points, and codimension 0 foliation  $\mathcal{C}_N = N$  with one leaf, equal to the whole manifold  $N$ . For example, the *trivial concordance* is the product  $\mathcal{F} \times I$ , where  $I = [0, 1]$ .

The product construction is defined also for (augmented) Haefliger structures. Again, the *trivial strong concordance* is the product  $\mathbf{H} \times I$ .

**2.2. Main theorems.** A strong concordance  $\tilde{\mathbf{H}}$  is called *regularizing* for an augmented Haefliger structure  $\mathbf{H} = \tilde{\mathbf{H}}_0$ , if its upper end  $\tilde{\mathbf{H}}_1$  is a foliation. The following theorem was proven by W. P. Thurston [Th1] (see also [ME]).

**THEOREM 2.2.1** (Regularization of augmented Haefliger structures). *Any augmented Haefliger structure  $\mathbf{H}$  of codimension  $> 1$  on a manifold  $M$  is strongly concordant to a foliation. If  $\mathbf{H}$  is already a foliation near a closed subset  $K \subset M$ , then the regularizing concordance can be chosen trivial near  $K$ . In particular, two foliations  $\mathcal{F}_0$  and  $\mathcal{F}_1$  on  $M$  are concordant (resp. strongly concordant) if and only if the associated augmented Haefliger structures  $\mathbf{H}_{\mathcal{F}_0}$  and  $\mathbf{H}_{\mathcal{F}_1}$  are concordant (resp. strongly concordant).*

See [Th1] for various corollaries of the theorem.

**REMARK.** The part of Theorem 2.2.1 concerning the existence of foliations is analogous to the corresponding statement in Gromov–Phillips–Haefliger’s *h*-principle for foliations on *open* manifolds (see [H]). However, the parametric part is weaker. Indeed, Gromov–Phillips–Haefliger’s theorem establishes a 1–1 correspondence between strong concordance classes of augmented Haefliger structures and *integrable homotopy classes* of foliations. This is not true for foliations on closed manifolds. Indeed, two foliations on a closed manifold are integrably homotopic if and only if they are *isotopic* (see [M]).

The next Theorem 2.2.2, first proven in [ME], establishes a connection between the relations of strong concordance and homotopy for foliations of codimension  $> 1$  on closed manifolds.

**THEOREM 2.2.2** (Strong concordance implies homotopy). *Two foliations  $\mathcal{F}_0$  and  $\mathcal{F}_1$  of codimension  $> 1$  are homotopic if and only if the associated augmented*

*Haefliger structures  $\mathbf{H}_{\mathcal{F}_0}$  and  $\mathbf{H}_{\mathcal{F}_1}$  are homotopic. In particular, if  $\mathcal{F}_0$  and  $\mathcal{F}_1$  are strongly concordant then they are homotopic.*

In fact, our methods allows us to prove the following multi-parametric version of Theorems 2.2.1 and 2.2.2.

**THEOREM 2.2.3** (Regularization of fibered augmented Haefliger structures). *Let  $\mathbf{H}_{D^k}$  be a fibered over  $D^k$  augmented Haefliger structure of codimension  $> 1$  on  $D^p \times M$ , such that  $\mathbf{H}_{D^p}$  is regular over  $\partial D^k$  (i.e.  $\mathbf{H}_{D^k}|_{p \times M}$  is a foliation for all  $p \in \partial D^k$ ). Then  $\mathbf{H}_{D^k}$  is fiberwise strongly concordant  $\text{rel} \partial D^k$  to a fibered foliation. In other words, there exists a fibered regularizing concordance  $\tilde{\mathbf{H}}_{D^k}$  for  $\mathbf{H}_{D^k}$ , such that  $\tilde{\mathbf{H}}_{D^k}$  is trivial over  $\partial D^k$ .*

Let us outline the proofs of Theorems 2.2.1 and 2.2.3.

First, in Sections 2.3 and 2.4 we improve an augmented Haefliger structure  $\mathbf{H}$  of Theorem 2.2.1 into an augmented Haefliger structure with (round) wrinkle-type singularities. This reduces the regularization of general singular foliations to the regularization of (round) wrinkles. Then, in Section 2.5 we construct a special foliation which plays a key role in the regularization of *round* wrinkles. Finally, in Sections 2.6 and 2.7, we regularize round wrinkles. This completes the proof of Theorem 2.2.3. Each of three steps has its natural fibered version, therefore the same scheme allows us to prove Theorem 2.2.3.

**2.3. Wrinkled mappings into foliations.** We need a slightly strengthened version of Theorems 1.4.1 and 1.4.2 and their round analogs. Let us start with some definitions.

Let  $\mathcal{L}$  be a foliation on a manifold  $Q$ . A map  $f : M \rightarrow Q$  is called *transversal to  $\mathcal{L}$* , if the reduced differential

$$TM \xrightarrow{df} TQ \xrightarrow{\pi_{\mathcal{L}}} \nu(\mathcal{L})$$

is an epimorphism. An open subset  $V \subset Q$  is called *elementary* (with respect to  $\mathcal{L}$ ), if  $\mathcal{L}|_V$  is generated by a submersion  $p_V : V \rightarrow \mathbb{R}^q$ .

An open subset  $U \subset M$  is called *small* (with respect to  $f$  and  $\mathcal{L}$ ), if  $f(U)$  is contained in an elementary subset of  $Q$ . A map  $f : M \rightarrow Q$  is called  $\mathcal{L}^\perp$ -*(round) wrinkled*, if there exist disjoint small subsets  $U_1, \dots, U_l \subset M$  such that  $f|_{M \setminus (U_1 \cup \dots \cup U_l)}$  is transversal to  $\mathcal{L}$  and for each  $i = 1, \dots, l$  the composition

$$U_i \xrightarrow{f|_{U_i}} V_i \xrightarrow{p_{V_i}} \mathbb{R}^q$$

(where  $V_i \supset f(U_i)$  is an elementary subset of  $Q$ ), is a (round) wrinkle. In order to get the *regularized* reduced differential

$$\mathcal{R}(\pi_{\mathcal{L}} \circ df) : TM \rightarrow \nu(\mathcal{L}),$$

we regularize the differential of each (round) wrinkle  $w_i = p_{V_i} \circ f|_{U_i}$  as in Sections 1.2 or 1.5 and then set

$$\mathcal{R}(\pi_{\mathcal{L}} \circ df|_{U_i}) = [dp_{V_i}|_{\nu(\mathcal{L})}]^{-1} \circ \mathcal{R}(dw_i).$$

Similarly to Section 1.3 we can define a *fibred*  $\mathcal{L}^\perp$ -(round) wrinkled map

$$\begin{array}{ccc} M & \xrightarrow{f} & Q \\ & \searrow p & \swarrow q \\ & & B \end{array}$$

where the foliation  $\mathcal{L}$  on  $Q$  is fibred over the same base  $B$ . Finally we define, as usually, the *regularization*

$$\mathcal{R}(\pi_{\mathcal{L}} \circ d_B f) : T_B M \rightarrow \nu_B(\mathcal{L})$$

of the fibred reduced differential

$$T_B M \xrightarrow{d_B f} TQ \xrightarrow{\pi_{\mathcal{L}}} \nu_B(\mathcal{L}).$$

**THEOREM 2.3.1** (Wrinkled mappings of manifolds into foliations). *Let  $\mathcal{L}$  be a foliation on a manifold  $Q$  and  $F : TM \rightarrow \nu(\mathcal{L})$  be an epimorphism which covers a map  $f : M \rightarrow Q$ . Suppose that  $f$  is transversal to  $\mathcal{L}$  in a neighbourhood of a closed subset  $K$  of  $M$ , and  $F$  coincides with the reduced differential  $\pi_{\mathcal{L}} \circ df$  over that neighbourhood. Then there exists a  $\mathcal{L}^\perp$ -(round) wrinkled map  $g : M \rightarrow Q$ , such that  $g$  coincides with  $f$  near  $K$  and, moreover,  $\mathcal{R}(\pi_{\mathcal{L}} \circ dg)$  and  $F$  are homotopic  $\text{rel}TM|_K$ .*

**PROOF.** Take a triangulation of the manifold  $M$  by *small* simplices. First we use Gromov–Phillips’ theorem (see [Ph], [Gr1]) to approximate  $f$  near the  $(n - 1)$ -skeleton of the triangulation by a map transversal to  $\mathcal{L}$ . Then using Theorem 1.4.1 (or its “round” version) for a neighbourhood  $U_i$  of every  $n$ -simplex  $\sigma_i$  and an elementary set  $V_i \supset f(U_i)$  we can approximate the map  $p_{V_i} \circ f|_{U_i}$  by a (round) wrinkled map. This approximation can be realized by a deformation of the map  $f$ , keeping it fixed on a closed subset of  $U_i$  where the map  $f$  has been already previously defined. This process produces the desired  $\mathcal{L}^\perp$ -(round) wrinkled map.  $\square$

Similarly, Theorem 1.4.2 can be generalized to the following fibred version of Theorem 2.3.1.

**THEOREM 2.3.2.** *Let  $f : M \rightarrow Q$  be a fibred over  $B$  map,  $\mathcal{L}$  a fibred over  $B$  foliation on  $Q$  and  $F : T_B(M) \rightarrow \nu_B(\mathcal{L})$  a fibred epimorphism which covers  $f$ . Suppose that  $f$  is fiberwise transversal to  $\mathcal{L}$  near a closed subset  $K \subset M$ , and  $F$  coincides with the fibred reduced differential*

$$T_B M \xrightarrow{d_B f} TQ \xrightarrow{\pi_{\mathcal{L}}} \nu_B(\mathcal{L})$$

near  $K$ . Then there exists a fibered  $\mathcal{L}^\perp$ -(round) wrinkled map  $g : M \rightarrow Q$  which extends  $f$  from a neighbourhood of  $K$ , and such that the fibered epimorphisms  $\mathcal{R}(\pi_{\mathcal{L}} \circ d_B g)$  and  $F$  are homotopic  $\text{rel}T_B(M)|_K$ .

**2.4. Wrinkled foliations.** We reduce in this section the regularization of augmented Haefliger structures to the regularization of (round) wrinkles. As usual, the “round” version is valid only for  $q \geq 2$ .

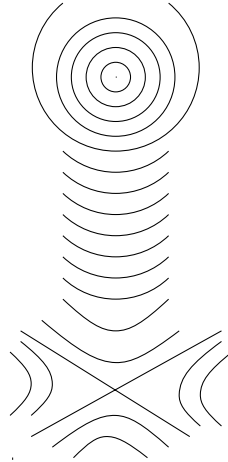

FIGURE 7. Foliation  $\mathcal{S}(2, 1, 0)$

Let  $\mathcal{O}_{\mathbb{R}^q}$  be the trivial codimension  $q$  foliation on  $\mathbb{R}^q$ . The standard wrinkle  $w(n, q, s)$  defines, outside of its singularity  $\Sigma(w) \subset \mathbb{R}^n$  (see 1.2), a foliation  $\mathcal{S}(n, q, s) = w^* \mathcal{O}_{\mathbb{R}^q}$ . See, for example, the foliations  $\mathcal{S}(2, 1, 0)$  on Figure 7,  $\mathcal{S}(3, 1, 1)$  on Figure 8 and  $\mathcal{S}(3, 2, 0)$  on Figure 9. Notice that the foliations  $\mathcal{S}(n, q, s)$  and  $\mathcal{S}(n, q, n - q - s)$  coincide up to the reflection  $z \mapsto -z$ .

Similarly, the map  $w_\circ(n, q, s)$  defines, outside of its singularity, a foliation  $\mathcal{S}_\circ(n, q, s) = w_\circ^* \mathcal{O}_{S^1 \times \mathbb{R}^{q-1}}$ . Notice, that  $\mathcal{S}_\circ(n, q, s) = \mathcal{O}_{S^1} \times \mathcal{S}(n - 1, q - 1, s)$ .

Let  $\mathbf{S}(n, q, s) = [\mathcal{R}(dw)|_{W^n}]^* \mathcal{O}_{\mathbb{R}^q}$  and  $\mathbf{S}_\circ(n, q, s) = [\mathcal{R}(dw_\circ(n, q, s)|_{W_\circ^n})]^* \mathcal{O}_{S^1 \times \mathbb{R}^{q-1}}$  be the augmented Haefliger structures on  $W^n$  and  $W_\circ^n$ , where the open neighbourhoods  $W^n \supset D^q$  and  $W_\circ^n \supset S^1 \times D^{q-1}$  should be, as usual, chosen sufficiently small (see the remark in Section 1.2). Notice, that  $\mathbf{S}_\circ(n, q, s) = S^1 \times \mathbf{S}(n - 1, q - 1, s)$  and that the underlying foliations for  $\mathbf{S}(n, q, s)|_{W^n \setminus \Sigma(w)}$  and  $\mathbf{S}_\circ(n, q, s)|_{W_\circ^n \setminus \Sigma(w_\circ)}$  are  $\mathcal{S}(n, q, s)|_{W^n \setminus \Sigma(w)}$  and  $\mathcal{S}_\circ(n, q, s)|_{W_\circ^n \setminus \Sigma(w_\circ)}$ .

An augmented Haefliger structure  $\mathbf{H} = (\nu, \mathcal{H}, i)$  on a manifold  $M$  is called a (round) wrinkled foliation if the inclusion  $s : M \rightarrow \nu$  (zero-section) is a  $\mathcal{H}^\perp$ -(round) wrinkled map and the regularization  $\mathcal{R}(\pi_{\mathcal{H}} \circ ds)$  is a left inverse to  $i$ .

In order to regularize any (round) wrinkled foliation it is sufficient to regularize the standard (round) wrinkled foliations  $\mathbf{S}(n, q, s)$  (resp.  $\mathbf{S}_\circ(n, q, s)$ ) in the



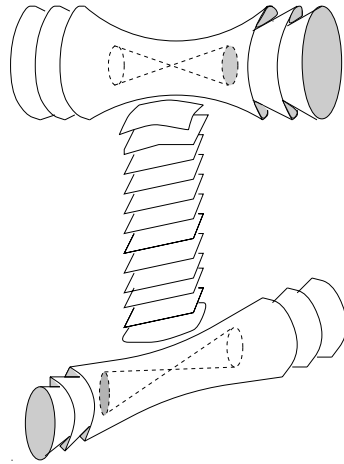

FIGURE 8. Foliation  $S(3,1,1)$

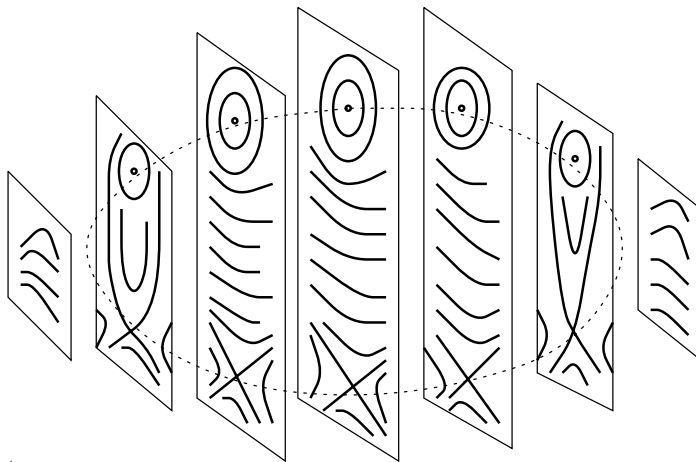

FIGURE 9. Foliation  $S(3,2,0)$

round version). In other words, it is sufficient to construct a regularizing strong concordances for  $\mathbf{S}(n, q, s)$  (resp.  $\mathbf{S}_\circ(n, q, s)$ ), which are trivial near the boundary of the closure  $\overline{W}^n$  (resp.  $\overline{W}_\circ^n$ ). The required concordance for the *round wrinkles*  $\mathbf{S}_\circ(n, q, s)$  ( $q \geq 2$ ) will be described in Section 2.7 below.

The following theorem reduces the regularization of any augmented Haefliger structures to regularization of (round) wrinkled foliations.

**THEOREM 2.4.1 (Reduction to wrinkled foliations).** *Any augmented Haefliger structure  $\mathbf{H}$  is strongly concordant to a (round) wrinkled foliation. If  $\mathbf{H}$  is already a foliation in a neighbourhood of a closed subset  $K \subset M$ , then the concordance can be chosen trivial near  $K$ .*

PROOF. Let  $(\nu, \mathcal{H}, i)$  be an augmented Haefliger structure on a manifold  $M$ , and  $F : TM \rightarrow \nu$  be a left inverse for  $i$ . Consider the bundle epimorphism  $\Phi = j \circ F : TM \rightarrow \nu(\mathcal{H})$  where  $j$  is the natural identification  $\nu \simeq \nu(\mathcal{H})|_M$ . Applying 1.4.1 to  $\Phi$  we can construct a homotopy  $\Phi_t$  between  $\Phi$  and  $\mathcal{R}(\pi_{\mathcal{H}} \circ dg)$  where  $g : M \rightarrow \nu$  is a  $\mathcal{H}^\perp$ -(round) wrinkled map. Then  $\Phi_t^*(\mathbf{H})$  is the desired concordance.  $\square$

In the fibered case the only difficulty is an awkward terminology: “a fibered (round) wrinkled foliation” is not very inspiring. Let us call the corresponding object a *fibered  $w$ -foliation* or a *family of  $w$ -foliations*, both in the round and usual cases. Notice that as in the case of fibered wrinkled maps, the family of augmented Haefliger structures which forms a fibered  $w$ -foliation does not consist only of (round) wrinkled foliations, but may also include foliations with (round) embryo singularities (see 1.3 and 1.5).

Here is the fibered version of Theorem 2.4.1.

THEOREM 2.4.2 (Reduction to a fibered  $w$ -foliation). *Let  $\mathbf{H}_{D^k}$  be a fibered augmented Haefliger structure on a  $D^k \times M$  which is regular over  $\partial D^k$ . Then it is fiberwise strongly concordant rel  $\partial D^k$  to a fibered  $w$ -foliation. In particular, if two foliations  $\mathcal{F}_0$  and  $\mathcal{F}_1$  are homotopic through a family of augmented Haefliger structures, then they are homotopic through a  $w$ -family of foliations.*

In order to regularize a fibered  $w$ -foliation it is sufficient, similarly to the non-parametric case, to regularize some standard models. Namely, for the  $k$ -parametric case we should regularize  $\mathbf{S}_o(n+k, q+k, s)$  fiberwise with respect to the projection to  $\mathbb{R}^k$ . In fact, the regularization of  $\mathbf{S}_o(n, q, s)$ , which will be described in Section 2.7, automatically preserves the fibered structure with respect to the projection to  $\mathbb{R}^{q-2}$ . Therefore, no additional considerations for the fibered case are needed.

**2.5. Filling of the standard hole.** The goal of this section is to construct a special 2-dimensional foliation on  $D^3 \times S^1$ , which will play an important role in the regularization of round wrinkles  $\mathbf{S}_o(n, q, s)$  discussed in the previous section.

Notice that a homotopy  $\mathcal{F}_t, t \in [0, 1]$ , of  $k$ -dimensional foliations on a manifold  $M$  can be viewed as a  $k$ -dimensional foliation  $\{\mathcal{F}_t\}$  on  $M \times [0, 1]$  by inscribing the foliation  $\mathcal{F}_t$  into the slice  $M \times t$  for each  $t \in [0, 1]$ .

Any non-vanishing vector field integrates to a foliation, and homotopic vector fields generate homotopic foliations. For instance, take a vector field

$$v = \cos \alpha(x) \frac{\partial}{\partial x} + \sin \alpha(x) \frac{\partial}{\partial y}$$

on the annulus  $[0, 1] \times S^1$ , where coordinates  $x$  and  $y$  correspond to the two factors, and denote by  $\mathcal{U}_\alpha$  the foliation generated by the vector field  $v$ . Then we have:

PROPOSITION 2.5.1. *For any two functions  $\alpha, \beta : [0, 1] \rightarrow [-\pi/2, \pi/2]$  which coincide on the boundary of the interval  $[0, 1]$  the corresponding foliations  $\mathcal{U}_\alpha$  and  $\mathcal{U}_\beta$  are homotopic relative to the boundary.*

Given a diffeomorphism  $\varphi : M \rightarrow M$  we denote by  $\mathcal{S}_\varphi$  its *suspension*, i.e. a one-dimensional foliation on  $M \times S^1$ , obtained from the foliation by intervals  $x \times [0, 1]$ ,  $x \in M$ , on  $M \times I$ , by gluing the boundary components  $M \times 0$  and  $M \times 1$  via the diffeomorphism  $\varphi$ .

Even simple geometric pictures are not so easy to visualize when they are described algebraically on the paper. To facilitate the understanding we try to draw the key steps of the construction presented in Proposition 2.5.2 below.

PROPOSITION 2.5.2 (Filling the hole). *Let  $\mathcal{D}$  be the group of diffeomorphisms of  $D^1 = [-1, 1]$  fixed near the boundary  $\partial D^1$ . Then there exists a continuous map  $\varphi \mapsto \mathcal{F}_\varphi$ , which associates to every diffeomorphism  $\varphi \in \mathcal{D}$  a 2-dimensional foliation  $\mathcal{F}_\varphi$  on  $D^1 \times D^2 \times S^1$  such that:*

- $\mathcal{F}_\varphi$  coincides with the foliation  $\mathcal{O}_{D^1} \times D^2$  near  $\partial D^1 \times D^2$ ;
- $\mathcal{F}_\varphi$  is transverse to  $D^1 \times \partial D^2 \times S^1$  and intersects  $D^1 \times \partial D^2 \times S^1$  along the foliation  $\mathcal{S}_\varphi \times S^1$ ;
- the foliation  $\mathcal{F}_{\text{Id}}$  is homotopic relative to the boundary to the product foliation  $\mathcal{O}_{D^1} \times D^2 \times \mathcal{O}_{S^1}$ .

REMARK. It is interesting to point out that although near the boundary  $\partial(D^1 \times D^2 \times S^1)$  the foliation  $\mathcal{F}_\varphi$  is the product of a 2-dimensional foliation  $\mathcal{T}_\varphi$ , which we will call *helical*, and the trivial foliation  $\mathcal{O}_{S^1}$ , one cannot, as it follows from the Reeb stability theorem (see [R]), extend the foliation  $\mathcal{T}_\varphi$  from  $D^1 \times \partial D^2$  to  $D^1 \times D^2$ . It will be sometimes convenient to view the helical foliation  $\mathcal{T}_\varphi$  as defined near the boundary of a smooth 3-ball  $D^3$  inscribed into the cylinder  $D^1 \times D^2$ . The 1-dimensional singular foliation defined by  $\mathcal{T}_\varphi$  on the boundary  $\partial D^3$  is shown on Figure 10.

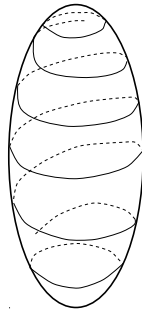

FIGURE 10. Foliation  $\mathcal{T}_\varphi|_{\partial D^3}$

PROOF. It will be convenient to make some preliminary rescaling. First, we will assume that the diffeomorphism  $\varphi$  is defined on the interval  $D_2^1 = [-2, 2]^2$ , and that it equals the identity in a neighbourhood of  $D_2^1 \setminus \text{Int}D^1$ . The restriction of  $\varphi$  to  $D^1$  will be also denoted by  $\varphi$ ; the distinction should be clear from the context. Second, we will substitute the unit disk  $D^2 = D_1^2$  by the disk  $D_4^2$  of radius 4.

Let us start with the foliation  $\mathcal{S}_\varphi$  on  $D^1 \times S^1$ . This  $S^1$  will correspond in our construction to the boundary  $\partial D^2$  in the product  $D^1 \times D^2 \times S^1$ , so we will denote it by  $S_h^1$  and call the *horizontal* circle, in order do not confuse it with the other, *vertical* circle  $S^1$ , which corresponds to the last factor in the product  $D^1 \times D^2 \times S^1$ .

Fix a  $C^\infty$ -function  $\alpha : [0, 1] \rightarrow [0, \pi/2]$ , such that

$$\alpha(r) = \begin{cases} \pi/2 & \text{for } r \text{ close to } 0, \\ 0 & \text{for } r \text{ close to } 1. \end{cases}$$

Consider the foliation  $\mathcal{U} = \mathcal{U}_\alpha$  on  $[3, 4] \times S^1$  generated by the vector field

$$\cos \alpha(r - 3) \frac{\partial}{\partial r} + \sin \alpha(r - 3) \frac{\partial}{\partial y}, \quad r \in [3, 4], \quad y \in S^1,$$

see Figure 11, and denote by  $\mathcal{F}_{[3,4]}$  the product-foliation  $\mathcal{S}_\varphi \times \mathcal{U}$  on  $D^1 \times S_h^1 \times [3, 4] \times S^1$ .

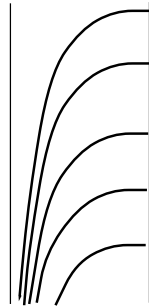

FIGURE 11. Foliation  $\mathcal{U}_\alpha$

The group  $\mathcal{D}$  is contractible. Thus one can canonically choose an isotopy  $\varphi_r : D^1 \rightarrow D^1$ ,  $r \in [2, 3]$ ,  $\varphi_r \in \mathcal{D}$ , such that  $\varphi_r = \varphi$  for  $r$  close to 3 and  $\varphi_r = \text{Id}$  for  $r$  close to 2. The family of foliations  $\mathcal{S}_{\varphi_r}$  on  $D^1 \times S_h^1$  defines a foliation  $\{\mathcal{S}_{\varphi_r}\}$  on  $D^1 \times S_h^1 \times [2, 3]$ . Take the product  $\{\mathcal{S}_{\varphi_r}\} \times S^1$  and denote the resulting foliation on  $D^1 \times S_h^1 \times [2, 3] \times S^1$  by  $\mathcal{F}_{[2,3]}$ . Notice that the foliations  $\mathcal{F}_{[3,4]}$  and  $\mathcal{F}_{[2,3]}$  nicely fit together into a foliation  $\mathcal{F}_{[2,4]}$  on  $D^1 \times S_h^1 \times [2, 4] \times S^1$ .

---

<sup>2</sup>We denote by  $D_r^k$  the disk of radius  $r$  in  $\mathcal{R}_k$ , centered at the origin and write  $D^k$  instead of  $D_1^k$ .

To extend the foliation  $\mathcal{F}_{[2,4]}$  to  $D^1 \times S_h^1 \times [1, 2] \times S^1$  take a foliation  $\mathcal{U}_\beta$  on  $[1, 2] \times S^1$  (see Figure 11), generated by the vector field

$$\cos \beta(r) \frac{\partial}{\partial r} + \sin \beta(r) \frac{\partial}{\partial y}, \quad r \in [1, 2], \quad y \in S^1,$$

where  $\beta(r) = -\alpha(2 - r)$ , and  $\alpha : [0, 1] \rightarrow [0, \pi/2]$  is the function which had been defined above.

Let  $\mathcal{F}_{[1,2]}$  denote the product-foliation  $\mathcal{O}_{D^1} \times S_h^1 \times \mathcal{U}_\beta$  on  $D^1 \times S_h^1 \times [1, 2] \times S^1$ . The foliations  $\mathcal{F}_{[1,2]}$  and  $\mathcal{F}_{[2,4]}$  agree along the common boundary, and thus define a foliation  $\mathcal{F}_{[1,4]}$  on  $D^1 \times S_h^1 \times [1, 4] \times S^1$ .

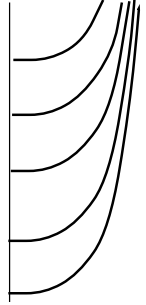

FIGURE 12. Foliation  $\mathcal{U}_\beta$

Notice that the foliation  $\mathcal{F}_{[1,4]}$  coincides near  $D^1 \times S_h^1 \times \{1, 4\} \times S^1$  with the foliation  $\mathcal{A}$  by annuli  $z \times S_h^1 \times [1, 4] \times y$ ,  $z \in D^1$ ,  $y \in S^1$ . Our next step will be to extend the foliation  $\mathcal{F}_{[1,4]}$  to  $[-2, 2] \times S_h^1 \times [1, 4] \times S^1$  so that it would coincide with the foliation  $\mathcal{A}$  near the whole boundary of the manifold  $[-2, 2] \times S_h^1 \times [1, 4] \times S^1$ . Let us observe that the foliation  $\mathcal{F}_{[1,4]}$  is tangent to  $\pm 1 \times S_h^1 \times [1, 4] \times S^1$ , and that its restriction to the torical annuli  $A_{\pm 1} = \pm 1 \times S_h^1 \times [1, 4] \times S^1$  is the product of the trivial (codimension 0) foliation  $S_h^1$  with the foliation  $\mathcal{U}_\gamma$  on  $[1, 4] \times S^1$ , defined by the vector field

$$\cos \gamma(r) \frac{\partial}{\partial r} + \sin \gamma(r) \frac{\partial}{\partial y}, \quad r \in [1, 4], \quad y \in S^1,$$

where

$$\gamma(r) = \begin{cases} -\alpha(2 - r) & r \in [1, 2], \\ \pi/2 & r \in [2, 3], \\ \alpha(3 + r) & r \in [3, 4], \end{cases}$$

see Figure 13.

According to Lemma 2.5.1 the foliation  $\mathcal{U}_\gamma$  is homotopic, relative to the boundary, to the foliation  $\mathcal{U}_0$  defined by the vector field  $\partial/\partial r$ , which is the foliation by intervals  $[1, 4] \times y$ ,  $y \in S^1$ . This homotopy  $\tilde{\mathcal{U}}_z$ ,  $z \in [1, 2]$ , can be chosen in the form  $\tilde{\mathcal{U}}_z = \mathcal{U}_{\gamma_z}$  where  $\gamma_z = \gamma\theta_z$ , where  $\theta : [0, 2] \rightarrow [0, 1]$  is a cut-off

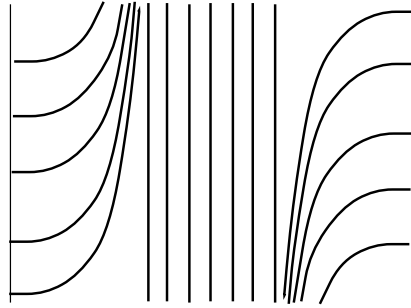

FIGURE 13. Foliation  $\mathcal{U}_\gamma$

function, equal 1 on  $[0, 1]$ , and 0 near 2. Thus it defines a 1-dimensional foliation  $\{\tilde{\mathcal{U}}_z\}$  on  $[1, 2] \times [1, 4] \times S^1$ , and a foliation  $\{\tilde{\mathcal{U}}_{-z}\}$  on  $[-2, -1] \times [1, 4] \times S^1$ . The product-foliations  $\mathcal{F}_\pm = S^1_h \times \{\tilde{\mathcal{U}}_{\pm z}\}$  on  $[1, 2] \times S^1_h \times [1, 4] \times S^1$  and  $[-2, -1] \times S^1_h \times [1, 4] \times S^1$  agree with  $\mathcal{F}_{[1,4]}$  along their common boundary, and thus together they define a foliation  $\mathcal{F}$  on  $[-2, 2] \times S^1_h \times [1, 4] \times S^1$ .

Let us identify the product  $S^1_h \times [1, 4]$  with the annulus  $\{1 \leq r \leq 4\} = D^2_4 \setminus \text{Int } D^2_1$ . We constructed, so far, a foliation  $\mathcal{F}$  on  $[-2, 2] \times (D^2_4 \setminus \text{Int } D^2_1) \times S^1$ , which coincides with the product-foliation  $\mathcal{O}_{[-2,2]} \times D^2_4 \times \mathcal{O}_{S^1}$  on  $[-2, 2] \times D^2_1 \times S^1$  near their common boundary  $[-2, 2] \times \partial D^2_1 \times S^1$ . Gluing these two foliations into one foliation on  $[-2, 2] \times D^2_1 \times S^1$  we get a foliation  $\mathcal{F}_\varphi$ , which is the goal of our construction.

Let us describe the foliation  $\mathcal{F}_\varphi$  on  $[-2, 2] \times D^2_4 \times S^1$  in a more informal way. Near the solid tori  $\pm 2 \times D^2_4 \times S^1$  the leaves of  $\mathcal{F}_\varphi$  are just the “horizontal” discs  $z \times D^2_4 \times y$ . As the point  $z \in [-2, 2]$  moves inside the interval  $[-2, 2]$ , an interior part of the solid torus  $z \times D^2_4 \times S^1$  begin spinning along  $S^1$  with an accelerating speed, pulling the discs inside, until at a certain moment they bubble off to cylinders, and a Reeb component inside is born (see Figure 14).

By the time  $z$  reaches  $\pm 1$  the foliation  $\mathcal{F}_\varphi$  is still inscribed into the foliation by solid tori  $z \times D^2_4 \times S^1$ , and for each fixed  $z$  it has a Reeb component  $z \times D^2_2 \times S^1$  inside, a layer of closed torical leaves  $z \times \partial D^2_r \times S^1$ ,  $r \in [2, 3]$ , and cylindrical leaves diffeomorphic to  $S^1 \times [0, \infty)$  which begin at the boundary and asymptotically converge to the exterior closed torical leaf  $z \times \partial D^2_3 \times S^1$  at their noncompact ends. As  $z$  moves further in, the Reeb component  $z \times D^2_2 \times S^1$  persists, while the leaves outside are no more horizontal. Instead, they are of two kinds. The leaves of the first kind are obtained by an accelerating rotation of the leaves of the foliation  $\mathcal{S}_\varphi$ , similar to the cylindrical leaves described above. The leaves of the second kind foliate the middle part  $D^1 \times (D^2_3 \setminus \text{Int } D^2_2) \times S^1$ . They are inscribed into the 3-dimensional torical annuli  $V_r = D^1 \times \partial D^2_r \times S^1$ ,  $r \in [2, 3]$ .

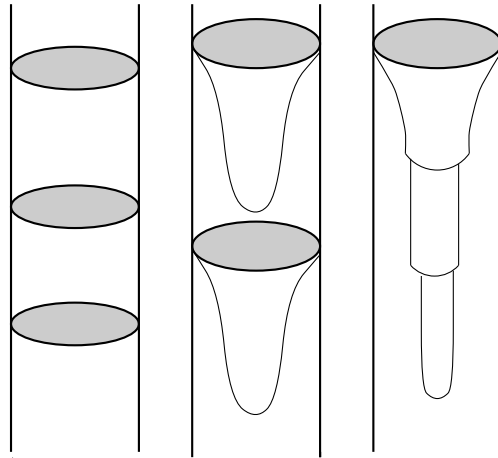

FIGURE 14. Towards the birth of a Reeb component

For each  $r \in [2, 3]$  the foliation  $\mathcal{F}_\varphi|_{V_r}$  is the product-foliation  $\mathcal{S}_{\varphi_r} \times S^1$ , where  $\varphi_r : D_1 \times D_1$  is the chosen isotopy between  $\varphi_3 = \varphi$  with  $\varphi_2 = \text{Id}$ .

To finish the proof it remains to show that the foliation  $\mathcal{F}_{\text{Id}}$  is homotopic, relative to the boundary, to the product-foliation  $\mathcal{O}_{[-2,2]} \times D_4^2 \times \mathcal{O}_{S^1}$ . On  $[-2, 2] \times D_1^2 \times S^1$  the foliations  $\mathcal{F}_{\text{Id}}$  and  $\mathcal{O}_{[-2,2]} \times D_4^2 \times \mathcal{O}_{S^1}$  already coincide. Thus it is sufficient to construct the homotopy on  $[-2, 2] \times (D_4^2 \setminus D_1^2) \times S^1 = [-2, 2] \times S_h^1 \times [1, 4] \times S^1$ , fixed near the boundary of this manifold. Let us observe that the foliation  $\mathcal{F}_{\text{Id}}$  is inscribed into the codimension 1 foliation by the ‘‘horizontal’’ torical annuli  $A_z = z \times S_h^1 \times [1, 4]$ ,  $z \in [-2, 2]$ . In other words,  $\mathcal{F}_{\text{Id}} = \{\mathcal{F}_z\}_{z \in [-2,2]}$ , where  $\mathcal{F}_z = \mathcal{F}_{\text{Id}}|_{A_z}$ . For each  $z \in [-2, 2]$  the foliation  $\mathcal{F}_z$  is itself the product  $S^1 \times \mathcal{U}_{\gamma_{|z|}}$ . The homotopy  $\{\mathcal{F}_z^t\} = S^1 \times \{\mathcal{U}_{(1-t)\gamma_{|z|}}\}$ ,  $t \in [0, 1]$ , on  $A_z$  connects the foliation  $\{\mathcal{F}_z\} = S^1 \times \{\mathcal{U}_{\gamma_{|z|}}\}$  with  $S^1 \times \{\mathcal{U}_0\} = S^1 \times [1, 4] \times \mathcal{O}_{S^1} = D_4^2 \setminus \text{Int } D_1^2 \times \mathcal{O}_{S^1}$ , and hence  $\{\mathcal{F}_z^t\}_{z \in [-2,2]}$  is the required homotopy between the foliations  $\mathcal{F}_{\text{Id}}$  and  $\mathcal{O}_{[-2,2]} \times D_4^2 \times \mathcal{O}_{S^1}$ .  $\square$

**2.6. Reduction to the standard holes.** Let us forget till Section 2.7 about augmented Haefliger structures, strong concordances and others decorations, and just try to extend the foliation  $\mathcal{S}(n, q, s)$  from the neighbourhood of  $\partial \overline{W}^n$  to the whole  $\overline{W}^n$ . Notice that  $\mathcal{S}(n, q, s)$  (likewise  $w(n, q, s)$ ) is a fibered object: it can be thought of as a family of codimension one foliations on  $\mathbb{R}^{n-q+1}$  which are parametrized by points  $p \in \mathbb{R}^{q-1}$ . These foliations are equivalent to  $\mathcal{S}(n - q + 1, 1, s)$  when  $p$  varies in a neighbourhood of the origin. However, their singularities fade out when  $p$  approaches to the boundary, so that the foliation becomes smooth and trivial when  $p$  crosses the boundary  $\partial D^{q-1}$  (look again at Figure 9).

PROPOSITION 2.6.1 (Regularization of  $\mathcal{S}(n, q, 0)$ ). *There exists a foliation  $\widehat{\mathcal{S}}(n, q, 0)$  on  $W^n$  which is orthogonal to the  $z$ -axis and coincides with  $\mathcal{S}(n, q, 0)$  near  $\partial\overline{W}^n$ .*

PROOF. To understand better the formal description below we recommend the reader to study first the foliation  $\widehat{\mathcal{S}}(2, 1, 0)$  shown at the right part of Figure 15. By rotating the picture around the  $z$ -axis we obtain  $\widehat{\mathcal{S}}(n, 1, 0)$ . The regularization procedure shown at the picture remains valid even when the wrinkle degenerates to an embryo. Hence  $\widehat{\mathcal{S}}(n, q, 0)$  can be constructed fiberwise.

Here is a formal description. Let us notice that the foliation  $\mathcal{S}(n, q, 0)$  can be considered as a family of foliations on  $y \times \mathbb{R}^{n-q} \times \mathbb{R}^1$ ,  $y \in \mathbb{R}^{q-1}$ , defined by the family of differential 1-forms  $3(z^2 + |y|^2 - 1)dz + d(|x|^2)$ , which depend on the parameter  $y \in \mathbb{R}^{q-1}$ . The required foliation  $\widehat{\mathcal{S}}(n, q, 0)$  can be defined by the family of forms  $\gamma(y, x, z)dz + d(|x|^2)$ , where the function  $\gamma$  coincides with  $3(z^2 + |y|^2 - 1)$  outside a small neighbourhood  $W_1^n$  of the disc  $D = \{z^2 + |y|^2 \leq 1, x = 0\}$ ,  $\overline{W}_1^n \subset W^n$ , and does not vanish along  $W_1^n \cap \{x = 0\}$ . In other words,  $\gamma$  is the function from the definition of  $\mathcal{R}(dw)$ , and our construction is just an observation that for  $s = 0$  the regularized differential  $\mathcal{R}(dw)$  defines a family of integrable plane fields on fibers  $y \times \mathbb{R}^{n-q} \times \mathbb{R}^1$ .  $\square$

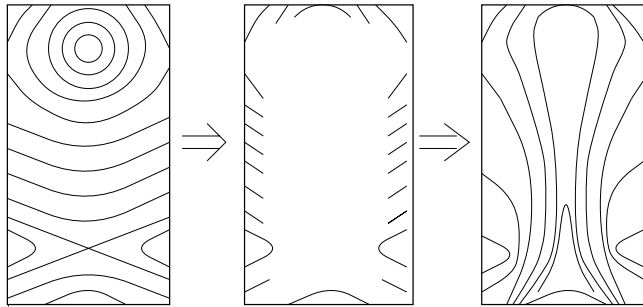

FIGURE 15. Regularization of  $\mathcal{S}(2, 1, 0)$

REMARK. The same construction works for  $s = n - q$ .

The following 3-dimensional model, along with the 4-dimensional model described in Proposition 2.5.2, is the base of the whole regularization project.

PROPOSITION 2.6.2 (Regularization of  $\mathcal{S}(3, 1, 1)$  up to four holes). *There exist an embedding  $h : K = S^0 \times S^0 \times D^3 \rightarrow W^3$  and a foliation  $\widehat{\mathcal{S}} = \widehat{\mathcal{S}}(3, 1, 1)$  on  $W^3 \setminus h(K)$ , such that  $\widehat{\mathcal{S}}$  coincides with  $\mathcal{S}(3, 1, 1)$  near  $\partial\overline{W}^3$  and coincides with a helical foliation  $\mathcal{T}_\varphi$  (see Figure 10) near the boundary of each of the four balls which form  $h(K)$ . In addition, the foliation  $\widehat{\mathcal{S}}$  is orthogonal to  $(x_1, z)$ - and  $(x_2, z)$ -planes in  $\mathbb{R}^3$ .*



PROOF. We may assume, that  $W^3 = \text{Int}(D_{1+\delta}^1 \times D_\delta^2)$  for a small  $\delta > 0$ . The foliation  $\mathcal{S} = \mathcal{S}(3, 1, 1)$  is defined by the function

$$(x_1, x_2, z) \mapsto (z^3 - 3z - x_1^2 + x_2^2)$$

(see Figure 8). Let  $P_1 = \{x_1 = 0\}$  and  $P_2 = \{x_2 = 0\}$ . Notice that  $\mathcal{S}|_{P_1 \cup P_2} = \mathcal{S}(2, 1, 0) \cup \mathcal{S}(2, 1, 1)$ ; see Figure 16, where the picture is drawn for  $x_1 \geq 0$  and  $x_2 \geq 0$ .

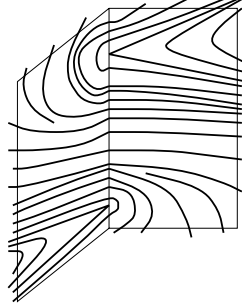

FIGURE 16. Foliation  $\mathcal{S}(3, 1, 1)|_{P_1 \cup P_2}$

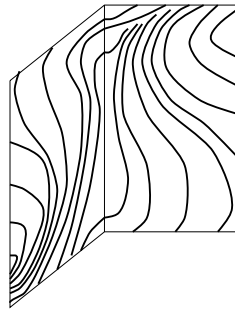

FIGURE 17. Foliations  $\widehat{\mathcal{S}}(2, 1, 0) \cup \widehat{\mathcal{S}}(2, 1, 1)$  on  $P_1 \cup P_2$

Consider the foliation  $\mathcal{F}_+ = \widehat{\mathcal{S}}(2, 1, 0) \cup \widehat{\mathcal{S}}(2, 1, 1)$  on  $P_1 \cup P_2$ , see Figure 17. We may assume, that the foliations  $\mathcal{F}_+$  and  $\mathcal{S}|_{P_1 \cup P_2}$  coincide on  $(P_1 \cup P_2) \cap (W^3 \setminus W_1^3)$  where  $W_1^3 = \text{Int}(D_{1+\delta_1}^1 \times D_{\delta_1}^2)$ ,  $\delta_1 < \delta$ . There exists an extension  $\widehat{\mathcal{F}}$  of the foliation  $\mathcal{F}_+$  into a neighbourhood  $U$  of  $P_1 \cup P_2$ , such that  $\widehat{\mathcal{F}}$  coincides with  $\mathcal{S}$  on  $U \cup (W^3 \setminus W_1^3)$  and orthogonal to  $P_1 \cup P_2$ . Set  $U_\varepsilon = \{|x_1 x_2| \leq \varepsilon\}$ . If  $\varepsilon$  is sufficiently small, then  $U_\varepsilon \subset U$  and the foliation  $\widehat{\mathcal{F}}$  is transversal to  $\partial U_\varepsilon$ . The foliation  $\mathcal{S}$  is transversal to  $\partial U_\varepsilon$ . However, the foliations  $\mathcal{S}|_{W^3 \setminus \text{Int} U_\varepsilon}$  and  $\widehat{\mathcal{F}}|_{U_\varepsilon}$  do not define a continuous foliation on  $W$  because they are mismatched along a part of their common boundary. Let us denote by  $\mathcal{F}_{\text{ext}}$  and  $\mathcal{F}_{\text{int}}$  the one-dimensional foliations  $\mathcal{S}|_{\partial U_\varepsilon}$  and  $\widehat{\mathcal{F}}|_{\partial U_\varepsilon}$ , see Figures 18 and 19.

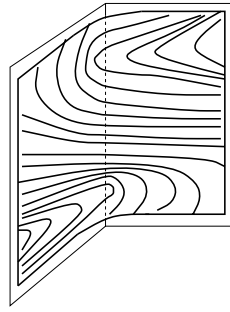

FIGURE 18. Foliation  $\mathcal{F}_{\text{ext}}$

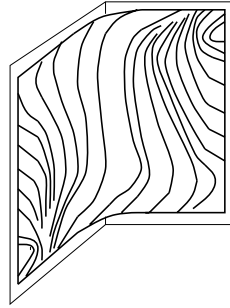

FIGURE 19. Foliation  $\mathcal{F}_{\text{int}}$

There exists an embedding  $h' : K' \rightarrow \partial U_\varepsilon \cap W^3$ ,  $K' = S^0 \times S^0 \times I^1 \times D^1$ , such that the foliations  $\mathcal{F}_{\text{ext}}$  and  $\mathcal{F}_{\text{int}}$  coincide outside of the image  $h'(K')$ . Moreover, near the boundary of each of the 4 squares  $p_i \times I^1 \times D^1$ ,  $p_i \in S^0 \times S^0$ ,  $i = 1, 2, 3, 4$ , the foliations  $(h')^*\mathcal{F}_{\text{int}}$  and  $(h')^*\mathcal{F}_{\text{ext}}$  coincide with the standard horizontal foliation  $I^1 \times \mathcal{O}_{D^1}$  on  $I^1 \times D^1$  (see Figure 20).

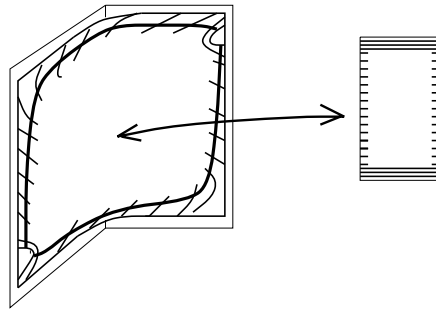

FIGURE 20. Embedding  $h'$

Let us cut  $W^3$  open along  $h'(K')$  and denote by  $\tilde{\mathcal{S}}$  the foliation defined by  $\mathcal{S}|_{W^3 \setminus \text{Int}U_\varepsilon}$  and  $\hat{\mathcal{F}}|_{U_\varepsilon}$  on  $W^3 \setminus h'(K')$ .

Taking a thin tubular neighbourhood of  $h'(K')$  we obtain an embedding

$$h : K = K' \times [-1, 1] = S^0 \times S^0 \times I^1 \times D^1 \times [-1, 1] \rightarrow W^3,$$

such that the induced foliation  $h^*(\widehat{\mathcal{S}})$  intersects  $S^0 \times S^0 \times I^1 \times D^1 \times \{-1\}$  along the foliation  $(h')^*\mathcal{F}_{\text{int}}$ , intersects  $S^0 \times S^0 \times I^1 \times D^1 \times \{1\}$  along  $(h')^*\mathcal{F}_{\text{ext}}$ , and coincides with the horizontal foliation  $\mathcal{O}_{D^1} \times (S^0 \times S^0 \times I \times [-1, 1])$  near the remaining part of the boundary of  $K$ . Thus near the boundary of each of the 4 balls  $B_i = p_i \times I \times D^1 \times [-1, 1]$ ,  $p_i \in S^0$ ,  $i = 1, 2, 3, 4$ , we get (up to smoothing the corners) a helical foliation  $\mathcal{T}_\varphi$  for a diffeomorphism  $\varphi : D^1 \rightarrow D^1$ , fixed near the boundary.  $\square$

Here is a fibered version of Proposition 2.6.2.

PROPOSITION 2.6.3 (Regularization of  $\mathcal{S}(q+2, q, 1)$  up to four holes). *There exist a fibered over  $D_{1+\varepsilon}^{q-1} \subset \mathbb{R}^{q-1}$  embedding*

$$h : K = D_{1+\varepsilon}^{q-1} \times S^0 \times S^0 \times D^3 \rightarrow W^{q+2} \subset \mathbb{R}^{q-1} \times \mathbb{R}^3,$$

and a fibered over  $\mathbb{R}^{q-1}$  foliation  $\widehat{\mathcal{S}} = \widehat{\mathcal{S}}(q+2, q, 1)$  on  $W^{q+2} \setminus h(K)$ , such that  $\widehat{\mathcal{S}}$  coincides with  $\mathcal{S}(q+2, q, 1)$  near  $\partial\overline{W}^{q+2}$  and coincide with a fibered foliation  $\mathcal{F}$  near the boundary of each component of  $h(K)$ , where

- $\mathcal{F}_p$  is a helical foliation  $\mathcal{T}_{\varphi_p}$  for  $p \in \text{Int } D_{1+\varepsilon}^{q-1}$ ,
- $\varphi_p = \text{Id}$  for  $p$  in a neighbourhood of  $\partial D_{1+\varepsilon}^{q-1}$ ,
- $\mathcal{F}_p$  is the trivial horizontal foliation defined on the whole  $h(p \times D^3)$  when  $p \in \partial D_{1+\varepsilon}^{q-1}$ .

Moreover, the two-dimensional fibered foliation  $\widehat{\mathcal{S}}(q+2, q, 1)$  is orthogonal to the  $(x_1, z)$ - and  $(x_2, z)$ -planes in  $p \times \mathbb{R}^3$  for every  $p \in D_{1+\varepsilon}^{q-1}$ .

PROOF. We can apply the previous construction fiberwise to the foliations  $\mathcal{S}(q+2, q, 1)|_{p \times \mathbb{R}^3}$ ,  $p \in \mathbb{R}^{q-1}$ , and observe that the corresponding foliations  $\mathcal{F}_{\text{ext}}^p$  and  $\mathcal{F}_{\text{int}}^p$ , defined on the fiber  $p \times \mathbb{R}^3$ , coincide when  $p$  is close to the boundary  $\partial D_{1+\varepsilon}^{q-1}$ , and thus the diffeomorphism  $\varphi_p$  which defines  $\mathcal{T}_{\varphi_p}$  is equal to the identity.  $\square$

PROPOSITION 2.6.4 (Reduction of  $\mathcal{S}(n, 1, s)$  to  $\mathcal{S}(3, 1, 1)$ ). *Let  $1 \leq s \leq n - q - 1$ . There exist an embedding  $h : K = S^{s-1} \times S^{n-s-2} \times D^3 \rightarrow W^n$  and a foliation  $\widehat{\mathcal{S}} = \widehat{\mathcal{S}}(n, 1, s)$  on  $W^n \setminus h(K)$  such that  $\widehat{\mathcal{S}}$  coincides with  $\mathcal{S}(n, 1, s)$  near  $\partial\overline{W}^n$  and coincides with a (codimension-one) foliation  $S^{s-1} \times S^{n-s-2} \times \mathcal{T}_\varphi$  near the boundary of  $h(K)$ . Here  $\mathcal{T}_\varphi$  is a helical foliation near the boundary of  $D^3$ .*

PROOF. Set  $\bar{x}_1 = (x_1, \dots, x_s)$ ,  $\bar{x}_2 = (x_{s+1}, \dots, x_{n-1})$ ,

$$|\bar{x}_1| = \left( \sum_1^s x_i^2 \right)^{1/2}, \quad |\bar{x}_2| = \left( \sum_{s+1}^{n-1} x_j^2 \right)^{1/2},$$

and denote by  $r_s : \mathbb{R}^n \rightarrow \mathbb{R}^3$  the map

$$(x_1, x_2, z) \mapsto (|\bar{x}_1|, |\bar{x}_2|, z).$$

Set  $\bar{P}_1 = \{\bar{x}_1 = 0\}$  and  $\bar{P}_2 = \{\bar{x}_2 = 0\}$ . The restriction  $r_s|_{\mathbb{R}^n \setminus (\bar{P}_1 \cup \bar{P}_2)}$  is a smooth trivial fibration with fibers diffeomorphic to  $S^{s-1} \times S^{n-s-2}$ . Notice that  $w(n, 1, s) = r_s \circ w(3, 1, 1)$ , and hence  $\mathcal{S}(n, 1, s) = r_s^*(\mathcal{S}(3, 1, 1))$ . Hence the required foliation can be defined as

$$\widehat{\mathcal{S}}(n, 1, s) = r_s^*(\widehat{\mathcal{S}}(3, 1, 1)).$$

In other word,  $\widehat{\mathcal{S}}(n, 1, s)$  is obtained from  $\widehat{\mathcal{S}}(3, 1, 1)$  by rotating around  $P_1$  and  $P_2$ . Notice that  $\widehat{\mathcal{S}}(n, 1, s)$  is smooth near the  $\bar{P}_1 \cup \bar{P}_2 \subset \mathbb{R}^n$ , because  $\widehat{\mathcal{S}}(3, 1, 1)$  is orthogonal to  $P_1$  and  $P_2$  (and moreover, can be chosen flat near  $P_1 \cup P_2$ ).  $\square$

Applying the same rotation construction to the foliation  $\widehat{\mathcal{S}}(q + 2, q, 1)$  from Proposition 2.6.3 we get

PROPOSITION 2.6.5 (The general case: regularization of  $\mathcal{S}(n, q, s)$  up to one hole). *Let  $1 \leq s \leq n - q - 1$ . There exist a fibered over  $D_{1+\varepsilon}^{q-1} \subset \mathbb{R}^{q-1}$  embedding*

$$h : K = D_{1+\varepsilon}^{q-1} \times S^{s-1} \times S^{n-q-s-1} \times D^3 \rightarrow W^n \subset \mathbb{R}^{q-1} \times \mathbb{R}^{n-q+1},$$

*and a fibered over  $\mathbb{R}^{q-1}$  foliation  $\widehat{\mathcal{S}} = \widehat{\mathcal{S}}(n, q, s)$  on  $W^n \setminus h(K)$ , such that  $\widehat{\mathcal{S}}$  coincides with  $\mathcal{S}(n, q, s)$  near  $\partial \overline{W}^n$  and coincides with the product-foliation  $S^{s-1} \times S^{n-q-s-1} \times \mathcal{F}$  near the boundary of each component of  $h(K)$ , where  $\mathcal{F}$  is the fibered foliation described in 2.6.3.*

**2.7. Regularization of round wrinkles.** Let us remind that  $\mathcal{S}_\circ(n, q, s)$  is the underlying foliation of the round wrinkle  $\mathbf{S}_\circ(n, q, s)$ .

PROPOSITION 2.7.1 (Regularization of  $\mathcal{S}_\circ(n, q, s)$ ). *There exists a foliation  $\widehat{\mathcal{S}}_\circ(n, q, s)$  on  $W_\circ^n$  such that  $\widehat{\mathcal{S}}_\circ(n, q, s) = \mathcal{S}_\circ(n, q, s)$  near the boundary of  $\overline{W}_\circ^n$ .*

PROOF. The key of the whole construction is the case  $\mathcal{S}_\circ(4, 2, 1)$  when we get the desired foliation  $\widehat{\mathcal{S}}_\circ(4, 2, 1)$  directly from 2.6.2 and 2.5.2. The general case with  $1 \leq s \leq n - q - 1$  follows from 2.6.5 and 2.5.2. The case  $s = 0$  (and  $s = n - q$ ) follows from 2.6.1.  $\square$

REMARK. The foliation  $\widehat{\mathcal{S}}_\circ(n, q, s)$  is fibered over  $\mathbb{R}^{q-2}$  (hence over  $\mathbb{R}^l$  for all  $l \leq q - 2$ ). Therefore, the foliation  $\widehat{\mathcal{S}}_\circ(n + k, q + k, s)$  regularizes the fibered over  $\mathbb{R}^k$  foliation  $\mathcal{S}_\circ(n + k, q + k, s)$  in the k-parametric case, see Section 2.4.

Proposition 2.7.1 and the round version of Theorem 2.4.1 prove the existence part of Thurston's theorem 2.2.1. Similarly, 2.7.1 and the round version of 2.4.2 prove Theorem 2.2.2 and the existence part of Theorem 2.2.3. In order to complete the proofs of Propositions 2.2.1 and 2.2.3 we should construct a regularizing strong concordance between  $\mathbf{S}_\circ(n, q, s)$  and  $\widehat{\mathcal{S}}_\circ(n, q, s)$ .

PROPOSITION 2.7.2 (Regularization of  $\mathbf{S}_\circ(n, q, s)$  by a strong concordance).  
 The augmented Haefliger structure  $\mathbf{S}_\circ(n, q, s)$  is strongly concordant rel  $\partial\overline{W}_\circ^n$  to the foliation  $\widehat{\mathcal{S}}_\circ(n, q, s)$ .

PROOF. We will use the foliation  $\widehat{\mathcal{S}}_\circ(n + 1, q, s)$  for the construction of the required strong concordance. Let us first show that the underlying (non-augmented) Haefliger structure  $\mathbb{S}_\circ(n, q, s)$  of  $\mathbf{S}_\circ(n, q, s)$  is concordant to the foliation  $\widehat{\mathcal{S}}_\circ(n, q, s)$ . Let  $h_0 : W_\circ^n \rightarrow W_\circ^{n+1}$  be the standard embedding

$$(y_1, \dots, y_{q-1}, x_1, \dots, x_{n-q}, z) \mapsto (y_1, \dots, y_{q-1}, x_1, \dots, x_{n-q}, 0, z).$$

Let us denote by  $U$  an open domain in  $W_\circ^{n+1}$ , such that  $\mathbb{S}_\circ(n + 1, q, s) = \widehat{\mathcal{S}}_\circ(n + 1, q, s)$  on  $W_\circ^{n+1} \setminus U$ . Let  $h_t : W_\circ^n \rightarrow W_\circ^{n+1}$  be a family of embeddings, fixed near  $\partial\overline{W}_\circ^n$ , and such that  $h_1(W_\circ^n) \subset W_\circ^{n+1} \setminus U$ . We have

$$h_0^*\mathbb{S}_\circ(n + 1, q, s) = \mathbb{S}_\circ(n, q, s)$$

and

$$h_0^*\widehat{\mathcal{S}}_\circ(n + 1, q, s) = \widehat{\mathcal{S}}_\circ(n, q, s).$$

On the other hand,

$$h_1^*\mathbb{S}_\circ(n + 1, q, s) = h_1^*\widehat{\mathcal{S}}_\circ(n + 1, q, s).$$

Thus, the required concordance can be obtained by gluing two concordances  $h_t^*\mathbb{S}_\circ(n + 1, q, s)$ ,  $t \in [0, 1]$ , and  $h_{2-t}^*\widehat{\mathcal{S}}_\circ(n + 1, q, s)$ ,  $t \in [1, 2]$ , together.

In order to augment the constructed concordance to a strong concordance, we should compare the canonical augmentation of the foliation  $\widehat{\mathcal{S}}_\circ(n, q, s)$  with the augmentation of  $\mathbf{S}_\circ(n, q, s)$  provided by the regularized differential  $\mathcal{R}(dw_\circ)$ . It is sufficient to consider the background cases  $\mathbf{S}_\circ(4, 2, 1)$  and  $\mathbf{S}_\circ(2, 1, 0)$ . The definition of  $\mathcal{R}(dw_\circ)$  and the construction of the foliation  $\widehat{\mathcal{S}}_\circ(4, 2, 1)$  guarantee that the two-dimensional plane fields  $\tau(\widehat{\mathcal{S}}_\circ(4, 2, 1))$  and  $\text{Ker } R(dw_\circ(4, 2, 1))$  (which are orthogonal to the underlying plane fields of our augmentations) are homotopic through a  $S^1$ -invariant family of plane fields, fixed near  $\partial W_\circ^4$ . Therefore, the two augmentations may differ only by a  $S^1$ -invariant and fixed near  $\partial W_\circ^4$  automorphism of the trivial two-dimensional vector bundle over  $W_\circ^4 \simeq S^1 \times D^3$ . But such an automorphism is homotopic to the identity since  $\pi_3(SO(2)) = 0$ . Similarly, in the case  $\mathbf{S}_\circ(2, 1, 0)$  the augmentations may differ only by an  $S^1$ -invariant and fixed near  $\partial W_\circ^3$  automorphism of the trivial two-dimensional vector bundle over  $W_\circ^3 \simeq S^1 \times D^2$ . Again, the automorphism is homotopic to the identity since  $\pi_2(SO(2)) = 0$ . □

## REFERENCES

- [B] E. BROWN, *Abstract homotopy theory*, Trans. Amer. Math. Soc. **119** (1965), 79–85.
- [E1] Y. ELIASHBERG, *On singularities of folding type*, Izv. Akad. Nauk. SSSR Ser. Mat. **34** (1970), 1111–1127.
- [E2] ———, *Surgery of singularities of smooth mappings*, Izv. Akad. Nauk. SSSR Ser. Mat. **36** (1972), 1321–1347.
- [EM1] Y. ELIASHBERG AND N.M. MISHACHEV, *Wrinkling of smooth mappings and its applications I*, Invent. Math. **130** (1997), 349–369.
- [EM2] ———, *Wrinkling of smooth mappings and its applications II. Wrinkling of embeddings and K. Igusa's theorem*, preprint 1994 (to appear).
- [F] D. B. FUCHS, *Foliations*, Algebra. Topology. Geometry **18** (1981), Moscow, 151–214.
- [Gr1] M. GROMOV, *Stable maps of foliations into manifolds*, Izv. Akad. Nauk. SSSR Ser. Mat. **33** (1969), 707–734.
- [Gr2] ———, *Partial Differential Relations*, Springer-Verlag, 1986.
- [H] A. HAEFLIGER, *Feuilletages sur les variétés ouvertes*, Topology **9** (1970), 183–194.
- [L] H. B. LAWSON, *Foliations*, Bull. Amer. Math. Soc. **80** (1974), 369–418.
- [M] M. J. MILNOR, *Foliations and foliated vector bundles*, mimeographed notes, 1970.
- [ME] N. M. MISHACHEV AND Y.M. ELIASHBERG, *Surgery of singularities of foliations*, Funct. Anal. Pril. **11** (1977), 43–53.
- [Ph] A. PHILLIPS, *Submersions of open manifolds*, Topology **6** (1967), 170–206.
- [R] G. REEB, *Sur certaines propriétés topologiques des variétés feuilletées*, Publ. Inst. Math. Univ. Strasbourg **11** (1952), Hermann, Paris, 91–154.
- [Th1] W.P. THURSTON, *The theory of foliations of codimension greater than one*, Comm. Math. Helvet. **49** (1974), 214–231.
- [Th2] ———, *Existence of codimension-one foliations*, Ann. of Math. **104** (1976), 249–268.
- [Th3] ———, *Noncobordant foliations of  $S^3$* , Bull. Amer. Math. Soc. **78** (1972), 511–514.

*Manuscript received June 16, 1998*

Y. ELIASHBERG  
Stanford University  
Stanford, CA 94305, USA

*E-mail address:* eliash@gauss.Stanford.edu

N. M. MISHACHEV  
Lipetsk Technical University  
Lipetsk, 398055, RUSSIA

*E-mail address:* mish@stu.lipetsk.su